



CALL NO. 401

CONTRACT ID. 182913

LAUREL - KNOX - BELL COUNTIES

FED/STATE PROJECT NUMBER 121GR18M081-FD04

DESCRIPTION US 25E BRIDGE PREVENTATIVE MAINTENANCE.

WORK TYPE BRIDGE DECK RESTORATION & WATERPROOFING

PRIMARY COMPLETION DATE 11/15/2019

LETTING DATE: October 26,2018

Sealed Bids will be received electronically through the Bid Express bidding service until 10:00 AM EASTERN DAYLIGHT TIME October 26,2018. Bids will be publicly announced at 10:00 AM EASTERN DAYLIGHT TIME.

NO PLANS ASSOCIATED WITH THIS PROJECT.

REQUIRED BID PROPOSAL GUARANTY: Not less than 5% of the total bid.

TABLE OF CONTENTS

PART I	SCOPE OF WORK
	<ul style="list-style-type: none">• PROJECT(S), COMPLETION DATE(S), & LIQUIDATED DAMAGES• CONTRACT NOTES• STATE CONTRACT NOTES• SPECIAL NOTE(S) APPLICABLE TO PROJECT• LIQUIDATED DAMAGES• SKETCH MAP(S)• MATERIAL SUMMARY
PART II	SPECIFICATIONS AND STANDARD DRAWINGS
	<ul style="list-style-type: none">• SPECIFICATIONS REFERENCE• SUPPLEMENTAL SPECIFICATION
PART III	EMPLOYMENT, WAGE AND RECORD REQUIREMENTS
	<ul style="list-style-type: none">• LABOR AND WAGE REQUIREMENTS• EXECUTIVE BRANCH CODE OF ETHICS• KENTUCKY EQUAL EMPLOYMENT OPPORTUNITY ACT OF 1978 LOCALITY / STATE• PROJECT WAGE RATES / STATE
PART IV	INSURANCE
PART V	BID ITEMS

PART I
SCOPE OF WORK

ADMINISTRATIVE DISTRICT - 11

CONTRACT ID - 182913

121GR18M081-FD04

COUNTY - BELL

PCN - MB00700251801
FD04 007 0025 B00131L,R

US 25E (MP 18.333). BRIDGE OVER OLD 25E AND CUMBERLAND RIVER.BRIDGE REPAIRS EXPANSION JOINTS
SYP NO. 11-10046.00.

GEOGRAPHIC COORDINATES LATITUDE 36:48:00.00 LONGITUDE 83:45:18.00

PCN - MB00700251802
FD04 007 0025 B00130L,R

US 25E (MP 17.786). BRIDGE OVER KY 2014 AND CUMBERLAND RIVER.BRIDGE REPAIRS EXPANSION JOINTS
SYP NO. 11-10046.00.

GEOGRAPHIC COORDINATES LATITUDE 36:47:33.00 LONGITUDE 83:45:10.00

PCN - MB00700251803
FD04 007 0025 B00026N

US 25E (MP 11.962). BRIDGE OVER CLEAR CREEK LANE.BRIDGE REPAIRS EXPANSION JOINTS SYP NO.
11-10046.00.

GEOGRAPHIC COORDINATES LATITUDE 36:44:31.00 LONGITUDE 83:41:38.00

PCN - MB00700251806
FD04 007 0025 B00126N

US 25E (MP 1.663). BRIDGE OVER LITTLE YELLOW CREEK.BRIDGE REPAIRS EXPANSION JOINTS SYP NO.
11-10046.00.

GEOGRAPHIC COORDINATES LATITUDE 36:36:27.00 LONGITUDE 83:42:06.00

PCN - MB00700251807
FD04 007 0025 B00137N

US 25E (MP 1.342). SKYLAND DRIVE BRIDGE OVER US25E.BRIDGE REPAIRS EXPANSION JOINTS SYP NO.
11-10046.00.

GEOGRAPHIC COORDINATES LATITUDE 36:36:18.00 LONGITUDE 83:41:51.00

PCN - MB00700251808
FD04 007 0025 B00136L,R

US 25E (MP 0.806). US 25E OVER PINNACLE VIEW ROAD.BRIDGE REPAIRS EXPANSION JOINTS SYP NO.
11-10046.00.

GEOGRAPHIC COORDINATES LATITUDE 36:36:17.00 LONGITUDE 83:41:17.00

COUNTY - KNOX

PCN - MB06100251801
FD04 061 0025 B00081L,R

US 25E (MP 14.635). BRIDGE OVER BIG RICHLAND CREEK.BRIDGE REPAIRS EXPANSION JOINTS SYP NO.
11-10046.00.

GEOGRAPHIC COORDINATES LATITUDE 36:54:44.00 LONGITUDE 83:54:16.00

PCN - MB06100251802
FD04 061 0025 B00082L,R

US 25E (MP 12.427). BRIDGE OVER LITTLE RICHLAND CREEK.BRIDGE REPAIRS EXPANSION JOINTS SYP NO.
11-10046.00.

GEOGRAPHIC COORDINATES LATITUDE 36:53:23.00 LONGITUDE 83:53:11.00

LAUREL - KNOX - BELL COUNTIES
121GR18M081-FD04

PCN - MB06100251803
FD04 061 0025 B00092L,R

US 25E (MP 4.505). BRIDGE OVER TURKEY CREEK.BRIDGE DECK RESTORATION & WATERPROOFING SYP NO.
11-10046.00.

GEOGRAPHIC COORDINATES LATITUDE 36:51:41.00 LONGITUDE 83:47:41.00

PCN - MB06100251804
FD04 0061 0025 B00091L,R

US 25E (MP 3.385). BRIDGE OVER STINKING CREEK.BRIDGE DECK RESTORATION & WATERPROOFING SYP
NO. 11-10046.00.

GEOGRAPHIC COORDINATES LATITUDE 36:50:47.00 LONGITUDE 83:47:10.00

PCN - MB06100251805
FD04 061 0025 B00090L,R

US 25E (MP 1.495). BRIDGE OVER CSX RR.BRIDGE DECK RESTORATION & WATERPROOFING SYP NO.
11-10046.00.

GEOGRAPHIC COORDINATES LATITUDE 36:49:19.00 LONGITUDE 83:46:23.00

PCN - MB06100251806
FD04 061 0025 B00089L,R

US 25E (MP 0.821). BRIDGE OVER CUMBERLAND RIVER.BRIDGE DECK RESTORATION & WATERPROOFING
SYP NO. 11-10046.00.

GEOGRAPHIC COORDINATES LATITUDE 36:48:49.00 LONGITUDE 83:45:58.00

COUNTY - LAUREL

PCN - MB06300251801
FD04 063 0025 B00058L,R

US 25E (MP 1.366). BRIDGE OVER CSX RR.BRIDGE DECK RESTORATION & WATERPROOFING SYP NO.
11-10046.00.

GEOGRAPHIC COORDINATES LATITUDE 36:58:27.00 LONGITUDE 84:06:03.00

COMPLETION DATE(S):

COMPLETED BY 11/15/2019

APPLIES TO ENTIRE CONTRACT

CONTRACT NOTES

PROPOSAL ADDENDA

All addenda to this proposal must be applied when calculating bid and certified in the bid packet submitted to the Kentucky Department of Highways. Failure to use the correct and most recent addenda may result in the bid being rejected.

BID SUBMITTAL

Bidder must use the Department's electronic bidding software. The Bidder must download the bid file located on the Bid Express website (www.bidx.com) to prepare a bid packet for submission to the Department. The bidder must submit electronically using Bid Express.

JOINT VENTURE BIDDING

Joint venture bidding is permissible. All companies in the joint venture must be prequalified in one of the work types in the Qualifications for Bidders for the project. The bidders must get a vendor ID for the joint venture from the Division of Construction Procurement and register the joint venture as a bidder on the project. Also, the joint venture must obtain a digital ID from Bid Express to submit a bid. A joint bid bond of 5% may be submitted for both companies or each company may submit a separate bond of 5%.

UNDERGROUND FACILITY DAMAGE PROTECTION

The contractor shall make every effort to protect underground facilities from damage as prescribed in the Underground Facility Damage Protection Act of 1994, Kentucky Revised Statute KRS 367.4901 to 367.4917. It is the contractor's responsibility to determine and take steps necessary to be in compliance with federal and state damage prevention directives. When prescribed in said directives, the contractor shall submit Excavation Locate Requests to the Kentucky Contact Center (KY811) via web ticket entry. The submission of this request does not relieve the contractor from the responsibility of contacting non-member facility owners, whom shall be contacted through their individual Protection Notification Center. Non-compliance with these directives can result in the enforcement of penalties.

REGISTRATION WITH THE SECRETARY OF STATE BY A FOREIGN ENTITY

Pursuant to KRS 176.085(1)(b), an agency, department, office, or political subdivision of the Commonwealth of Kentucky shall not award a state contract to a person that is a foreign entity required by [KRS 14A.9-010](#) to obtain a certificate of authority to transact business in the Commonwealth ("certificate") from the Secretary of State under [KRS 14A.9-030](#) unless the person produces the certificate within fourteen (14) days of the bid or proposal opening. If the foreign entity is not required to obtain a certificate as provided in [KRS 14A.9-010](#), the foreign entity should identify the applicable exception. Foreign entity is defined within [KRS 14A.1-070](#).

For all foreign entities required to obtain a certificate of authority to transact business in the Commonwealth, if a copy of the certificate is not received by the contracting agency within the time frame identified above, the foreign entity's solicitation response shall be deemed non-responsive or the awarded contract shall be cancelled.

Businesses can register with the Secretary of State at <https://secure.kentucky.gov/sos/ftbr/welcome.aspx>.

SPECIAL NOTE FOR PROJECT QUESTIONS DURING ADVERTISEMENT

Questions about projects during the advertisement should be submitted in writing to the Division of Construction Procurement. This may be done by fax (502) 564-7299 or email to kytc.projectquestions@ky.gov. The Department will attempt to answer all submitted questions. The Department reserves the right not to answer if the question is not pertinent or does not aid in clarifying the project intent.

The deadline for posting answers will be 3:00 pm Eastern Daylight Time, the day preceding the Letting. Questions may be submitted until this deadline with the understanding that the later a question is submitted, the less likely an answer will be able to be provided.

The questions and answers will be posted for each Letting under the heading "Questions & Answers" on the Construction Procurement website (www.transportation.ky.gov/contract). The answers provided shall be considered part of this Special Note and, in case of a discrepancy, will govern over all other bidding documents.

HARDWOOD REMOVAL RESTRICTIONS

The US Department of Agriculture has imposed a quarantine in Kentucky and several surrounding states, to prevent the spread of an invasive insect, the emerald ash borer. Hardwood cut in conjunction with the project may not be removed from the state. Chipping or burning on site is the preferred method of disposal.

INSTRUCTIONS FOR EXCESS MATERIAL SITES AND BORROW SITES

Identification of excess material sites and borrow sites shall be the responsibility of the Contractor. The Contractor shall be responsible for compliance with all applicable state and federal laws and may wish to consult with the US Fish and Wildlife Service to seek protection under Section 10 of the Endangered Species Act for these activities.

ACCESS TO RECORDS

The contractor, as defined in KRS 45A.030 (9) agrees that the contracting agency, the Finance and Administration Cabinet, the Auditor of Public Accounts, and the Legislative Research Commission, or their duly authorized representatives, shall have access to any books, documents, papers, records, or other evidence, which are directly pertinent to this contract for the purpose of financial audit or program review. Records and other prequalification information confidentially

disclosed as part of the bid process shall not be deemed as directly pertinent to the contract and shall be exempt from disclosure as provided in KRS 61.878(1)(c). The contractor also recognizes that any books, documents, papers, records, or other evidence, received during a financial audit or program review shall be subject to the Kentucky Open Records Act, KRS 61.870 to 61.884.

In the event of a dispute between the contractor and the contracting agency, Attorney General, or the Auditor of Public Accounts over documents that are eligible for production and review, the Finance and Administration Cabinet shall review the dispute and issue a determination, in accordance with Secretary's Order 11-004.

April 30, 2018

SPECIAL NOTE FOR RECIPROCAL PREFERENCE

RECIPROCAL PREFERENCE TO BE GIVEN BY PUBLIC AGENCIES TO RESIDENT BIDDERS

By reference, KRS 45A.490 to 45A.494 are incorporated herein and in compliance regarding the bidders residency. Bidders who want to claim resident bidder status should complete the Affidavit for Claiming Resident Bidder Status along with their bid in the electronic bidding software. Submittal of the Affidavit should be done along the bid in Bid Express.

April 30, 2018

**SPECIAL NOTE FOR BRIDGE CLEANING
AND PREVENTIVE MAINTENANCE**

1. DESCRIPTION. Perform all work in accordance with the Kentucky Transportation Cabinet, Department of Highway’s 2012 Standard Specification for Road and Bridge Construction applicable Supplemental Specifications, Standard Drawings, this Note and Attached Detailed Drawings. Section references are to the Standard Specifications. This work consists of the following: (1) Furnish all labor, materials, tools, and equipment; (2) All items included in Bridge Cleaning and Preventive Maintenance (3) Maintain and control traffic; (4) All other work required for this contract.

2. SUBMITTALS

The Contractor shall comply with the submittal requirements detailed in Section 108 of the Standard Specifications for Road and Bridge Construction (Current Edition) and submit the following **written** items to the Project Engineer **14 days** prior to the Pre-Construction Conference:

- A. A detailed Progress of Work Schedule.
- B. Traffic Control Plan.
- C. Manufacturers’ recommended Film Thickness and application conditions for the concrete coating system to be used.
- D. Manufactures’ specification and recommendations for concrete sealant to be used on bridge deck.

All submittals must be received, accepted and/or approved by the KYTC Engineer prior to beginning any work.

3. MATERIALS.

A. Wash Water

Use clean potable water for all pressure washing.

B. Concrete Coatings (End Bent, Abutment and Pier Caps)

Use one of the coatings from the following manufactures:

Manufacture	Prime Coat	Finish Coat
Sherwin Williams	Macropoxy 646	Acrolon 218 HS
PPG	Amberlock 2	Devoe Devflex
Carboline	Carboguard 890	Carbothane 133 HB
Tnemec	Elastogrip 151	EnviroCrete 15

C. Bearing Lubricant

Use one of the lubricants from the following manufactures:

Manufacture	Lubricant
Bostik Inc.,	Never Seez - Mariner’s Choice
Mobil Oil	Mobil Centaur Moly NLGI Grades 1 or 2
Certified Labs	Premalube #1 WG

D. Concrete Sealant (Bridge Deck and Parapets)

Product	Supplier
Protectosil BHN	Evonik Industries
Protectosil 300	Evonik Industries
TK-590-40 Tri-Silane 40%	TK Products
Certivex Penseal 244 O/W 80	Vexcon
Master Protect H 440 VT (formerly Hydrozo Clear 40 VOC)	BASF
SW-244-100 DOT	Chemical Products Industries, Inc.
TK-590-1 MS Tri-Silane	TK Products

3. CONSTRUCTION.

A. Bridge Cleaning.

All debris shall be removed from the bridge components. See attached detailed drawings for each bridge addressing components having debris removal. Equipment for removing debris from the bridge components shall be determined by the Contractor, subject to the approval of the Engineer. The Contractor shall prevent any debris from entering any body of water, bridge drainage system, or traffic lanes. All debris removed shall be disposed of in a suitable off-site disposal facility. Prior to all cleaning work, the Contractor shall confirm that any bridge drainage system is not blocked by un-removable debris. A blocked drainage system is considered to be one from which debris cannot be removed using the means specified in this note. If the Engineer has been notified, and concurs that the drainage system is blocked prior to performing other cleaning work, then proceed at the direction of the engineer. If the Contractor does not inspect the bridge drainage system and notify the engineer prior to beginning work any blocked drains will be considered to be the result of the Contractor's operations, and all clearing and cleaning of the drainage system shall be done as part of the work of the specification. All vegetation present at areas of the bridge that are to be addressed in this proposal shall be removed as determined by the Engineer. **All cost to complete Debris Removal, Clean Deck Drains and Remove Vegetation shall as specified shall be included in the Lump Sum price for "Bridge Cleaning".**

B. Stratified and Pack Rust Removal.

Stratified and pack rust shall be removed from all bearing devices and steel members from the end of beams. All existing bearing lubrication shall be removed. See attached detailed drawings for each bridge showing location and quantity of the bearing devices. Hand tools including wire brushes, scrapers or impact devices (hand hammers or power chisels) are to be used for removing stratified and pack rust. All surfaces to have stratified and pack rust removed shall be cleaned to an SSPC SP-2 level. All debris collected shall be disposed of in a suitable off-site disposal facility. **All cost to complete Stratified, Pack Rust Removal and removal of existing bearing lubricant shall be considered incidental to the unit price bid for "Lubricate Bearing".**

C. Pressure Washing.

Specified bridge components shall be pressure washed (for deck pressure washing see section F). See attached detailed drawings for each bridge addressing components to be pressure washed. All equipment for pressure washing shall be operated at a minimum pressure of up 4,000 psi with 0 degree spinner tip and/or fan tips as determined by the engineer at the working location with a minimum flow rate of 3.5 gal/minute provided that these pressures do not damage any components of the structure. Pressure and flow rates shall be reduced to a level satisfactory to the Engineer should any damage occur due to power washing procedures. Pressure washing shall be operated at distance of approximately six inches from and perpendicular to the surface. All pressure washing wands shall be equipped with a gauge to accurately determine the amount pressure used. Pressure washing of any bridge element will proceed from top of wash area to bottom of wash area. Wash water will not be released to a bridge element previously washed. Preform all pressure washing at temperatures above 40 degrees Fahrenheit. **All cost to complete Pressure Washing as specified shall be included in the Lump Sum price for Lump Sum price for “Bridge Cleaning”.**

D. Concrete Coatings Application.

All abutment, end bent and pier caps, pedestals, end bent back walls and parapet walls including the abutment and end bent wing walls shall have concrete coating applied to as specified after debris removal and power washing. Use compressed air to remove any loose debris from the surfaces that are to be coated after power washing. See concrete coating diagram. All coatings shall be applied within manufacturers recommended dry film thickness range. Comply with KYTC “Standard Specifications for Road and Bridge Construction” Section 614.03.02 and coatings supplier recommended conditions for application. Allow the surfaces to be coated to dry before any coating is applied. The coating must be applied to a clean and dry surface. All coating application shall be executed using brushes, rollers, etc. No spray application will be permitted. The Department requires acceptance testing of samples obtained on a per-lot basis per-shipment. The Division of Materials shall perform acceptance testing. Test samples shall be taken at the Contractor’s paint storage site. Department personnel shall perform sampling. Allow (10) working days for testing and approval of the sampled paint. It is the Contractor’s responsibility to maintain an adequate inventory of approved paint. The Department shall assume no responsibility for lost work due to rejection of paint or approved paint subsequently found to be defective during the application process. Preform all concrete coating application at temperatures above 40 degrees Fahrenheit or in accordance with manufactures specifications.

The finish coat shall be gray and will meet the following values.

	L*	a*	b*
Grey	74.94	- 1.54	3.92

All cost to complete Concrete Coating Application as specified shall be included in the Lump Sum price for “Concrete Coatings”.

Approximate square footage of concrete to have concrete coatings applied for each bridge follows:

063B00058L ~ 1750 Square Feet	007B00131L ~ 1700 Square Feet
061B00089L ~ 1400 Square Feet	007B00131R ~ 1700 Square Feet
063B00058R ~ 1750 Square Feet	061B00089R ~ 1400 Square Feet
007B00026N ~ 2600 Square Feet	061B00082L ~ 1500 Square Feet
007B00130L ~ 4500 Square Feet	061B00082R ~ 1500 Square Feet
007B00130R ~ 4500 Square Feet	061B00081R ~ 1550 Square Feet

The square footage listed for each bridge is for informational purposes only.

E. Bearing Lubrication Application.

Bearing devices shall be lubricated as specified after all stratified rust and pack rust is removed and power washing is complete, bearing devices shall have lubricant applied to all surfaces of the bearing including bearing plates and points of movement. See attached detailed drawings for each bridge showing location and quantity of the bearing devices. Allow bearing devices to dry before lubricant is applied. Perform all bearing lubrication application at temperatures above 40 degrees Fahrenheit or in accordance with manufacturer's specifications. All cost to complete Bearing Lubrication Application as specified shall be included in the unit price Each for "Lubricate Bearing".

F. Seal Bridge Deck.

Cleaning the Bridge Deck. Dry clean concrete surfaces to remove all loose debris. Remove all visible hydrocarbons from the surface with detergent approved by the manufacturer of the deck sealant. Pressure wash all surfaces to be sealed at 2000 to 3000 psi. Install pressure gauges at each wand to verify pressure. Use 30° fan tip or as recommended by the manufacturer of the deck sealant. Hold pressure washing wand a minimum of 45° from the deck with a maximum stand-off distance of 12 inches. This includes the entire surface area of the bridge deck, interior faces and top of parapet walls including the end bent/abutment wing walls.

Seal the Bridge Deck. All concrete to be sealed must be clean and dry. Monitor weather conditions prior to sealer application. Refer to manufacturer's recommendations for proper ambient conditions. Do not apply sealer if precipitation is anticipated within the time stated by the manufacturer. Allow the deck to dry 24 hours (after washing or rain event) before sealer application. The deck can be reopened to traffic while drying. Sealer must be applied within 48 hours of washing or the deck must be rewashed. Divide the deck into predefined areas of specific square footage to aid in determining usage. Comply with manufacturer's usage recommendation. Using a low pressure pump, apply sealer and spread evenly with broom or squeegee; do not allow pooling to remain. When each predefined area is complete, measure the amount of sealer used to verify proper usage. After sealing, follow manufacturer's recommended cure time before opening to traffic. This includes the entire surface area of the bridge deck, interior faces and top of parapet walls including the end bent/abutment wing walls.

All cost to complete Deck Sealing as specified shall be included in the Lump Sum price for “Seal Bridge Deck”.

G. Sequence of Work.

Complete work in the sequence listed below:

1. Debris Removal
2. Stratified Rust Removal
3. Pressure Washing
4. Concrete Coating Application
5. Rust Inhibitor Application
6. Bearing Lubrication Application
7. Bridge Deck Sealing

H. Access.

The Contractor shall provide OSHA compliant safe access for all bridge cleaning and preventive maintenance operations and inspection. Cost to furnish all items for access shall be considered incidental to the contract.

I. Inspection.

The Cabinet will provide inspection for all items required in this contract. Visual inspection will be required upon completion of each work item for each structure component or at the discretion of the Engineer at any time. All visual inspection shall be performed within arm's length distance.

1. **Debris Removal:** Visual Inspection
2. **Stratified Rust or Pack Rust Removal:** Visual Inspection and Scraper
Test any surface cleaned to SSPC SP2 will be inspected by a dull scraper test to ascertain adherence of existing coating and a hammer test for tightness of pack rust.
3. **Power Washing:** Visual Inspection.
4. **Concrete Coating:**
Prime Coat Application Check for dry film thickness*, and defects in paint
Finish Coat Application Check for dry film thickness*, paint appearance, color and quality of application.
*Destructive DFTs shall be used. Contractor shall repair all test locations, cost will be considered incidental to the contract.
5. **Bearing Greasing:** Visual Inspection.
6. **Sealing the Bridge Deck:** Visual Inspection

J. Verifying Field Conditions.

The Contractor shall be familiar with all conditions at each bridge site. The Cabinet will not consider any claims due to the Contractor having not familiarized themselves with requirements of this work.

K. Residual Lead.

Residual lead paint may still be on bridge. The Contractor is advised to take all necessary protective measures including worker safety and environmental regulations when performing surface preparation. The Department will not consider any claims based on residual lead paint.

L. Damage to the structure.

The Contractor shall bear all responsibility and expense for any and all damage to the structure during the repair work, even to the removal and replacement of a fallen span, should the fallen span result from the Contractors actions.

4. MEASUREMENT.

Bridge Cleaning: The Cabinet will measure this item by Lump Sum, completed and accepted.

Concrete Coating: The Cabinet will measure this item by Lump Sum, completed and accepted.

Bearing Lubrication: The Cabinet will measure this item by Each, completed and accepted.

Seal Bridge Deck. The Department will measure the quantity by Lump Sum, completed and accepted.

5. PAYMENT.

Bridge Cleaning (24981EC): Payment at the contract unit price for “Lump Sum” is full compensation for Debris Removal, Deck Drain Cleaning, Pressure Washing and all incidental items required to complete this with as specified in this note and attached detailed drawings.

Concrete Coating (24982EC): Payment at the contract unit price for “Lump Sum” is full compensation for applying the concrete coatings and all incidental items required to complete this work as specified in this note and attached detailed drawings.

Bearing Lubrication (24983EC): Payment at the contract unit price “Each” is full compensation for applying bearing lubrication and all incidental items required to complete this work as specified in this note and attached detailed drawings.

Seal Bridge Deck (24439EC). Payment at the contract unit price for lump sum is full compensation for the following: (1) Furnish all labor, materials, tools, and equipment; (2) Clean existing bridge deck; (3) Seal the existing bridge deck; (4) Maintain & control traffic; and, (5) Any other work specified as part of this contract.

SPECIAL NOTE FOR JOINT SEAL REPLACEMENT

- 1. DESCRIPTION.** Perform all work in accordance with the Kentucky Transportation Cabinet, Department of Highway's Standard Specifications for Road and Bridge Construction and applicable Supplemental Specifications (Current Editions), this note and attached detailed drawings. Section references are to the Standard Specifications. This work consists of the following: (1) Furnish all labor, materials, tools, and equipment; (2) Remove existing joint seal; (3) Install joint seal as specified (4) Maintain and control traffic; and (5) Any other work specified as part of this contract.
- 2. MATERIALS.**
 - A. Expansion Joint Seals.**
 - 1" ~ SSI SES-100, Watson Bowman Acme FS-100 or BEJS EMSEAL BEJS-ON-A-Reel.
 - 1 ½" ~ SSI SES 112, Watson Bowman Acme FS-150 or BEJS EMSEAL 1 ½" RJ Watson SF 150.
 - 2" ~ SSI SES-200, Watson Bowman Acme FS-200 or BEJS EMSEAL 2"
 - 2 ½" ~ SSI SES-212, Watson Bowman Acme FS-250 or BEJS EMSEAL 2 ½"
- 3. CONSTRUCTION.**
 - A. Remove Existing Materials.** Remove the existing seal and clean according to section 606.03.11 and as directed by the Engineer. Dispose of all removed material entirely away from the job site. This work is incidental to the contract unit price for "JOINT SEALING".
 - B. New Joint Material.** Use a system listed in 2. Materials to reseal joints. Install as recommended from the manufacture. Provide the engineer with the manufactures documents for installation
 - C. Verifying Field Conditions.** The Contractor shall field verify all joint openings, locations and manufacture before ordering any material. New material that is unsuitable due to variation in existing structure shall be replaced at the Contractors expense.
- 4. MEASUREMENT.**
 - A. Joint Seal Replacement.** The Department will measure the quantity in linear feet from gutter line to gutter line along the centerline of the joint. The Department will not measure the portion of the new seal extending through the barrier. The portion of the joint seal extending through the barriers will be considered incidental.
- 5. PAYMENT.**
 - A. Joint Seal Replacement (23386EC).** - Payment at the contract unit price per linear foot is full compensation for removing specified existing materials, furnishing and installing the new specified system, and all incidental items necessary to complete the work within the specified pay limits as specified by this note and the standard specification.

SPECIAL NOTE FOR REPLACING EXPANSION JOINTS AND/OR INSTALLING ARMORED EDGES FOR CONCRETE ON BRIDGES

1. DESCRIPTION. Perform all work in accordance with the Kentucky Transportation Cabinet, Department of Highway's 2008 Standard Specifications for Road and Bridge Construction and applicable Supplemental Specifications, the Standard Drawings, this Note, and the attached detail drawings. Section references are to the Standard Specifications. This work consists of the following: (1) Furnish all labor, materials, tools, and equipment; (2) Remove existing concrete and expansion joint(s) and/or bridge ends; (3) Install armored edges, modular expansion joint assembly and new concrete as specified and in accordance with the attached detail drawings; (4) Install new joint seals (where required); (5) Maintain and control traffic; and (6) Any other work specified as part of this contract.

2. MATERIALS.

A. Class "M" Concrete. Use either "M1" or "M2". See Section 601.

B. Structural Steel. Use new, commercial grade steel suitable for welding. The Engineer will base acceptance on visual inspection. See attach detailed drawings

C. Stud Anchors. The armored edge stud anchors are ¾" x 6" embedded stud shear connectors conforming to ASTM A108, Grade 1015

D. Steel Reinforcement. Use Grade 60. See Section 602.

E. Epoxy Bond Coat. See Section 511.

F. Joint Seals.

Pre-compressed Silicon and Hybrid Foam Joint Seals

1 ½" ~ SSI SES 112, Watson Bowman Acme FS-150 or BEJS EMSEAL 1 ½"

2" ~ SSI SES-200, Watson Bowman Acme FS-200 or BEJS EMSEAL 2"

2 ½" ~ SSI SES-212, Watson Bowman Acme FS-250 or BEJS EMSEAL 2 ½"

4" ~ SSI SES-400, RJ Watson SF-400, Watson Bowman Acme SF-400 or
BEJS EMSEAL (4") or DS Brown V-400. **(Parapet for 4" Strip Seal)**

4" Neoprene Strip Seals.

See Section 807.03.03.

3. EQUIPMENT.

A. Hammer. Provide Power driven hammers lighter than nominal 45 lb. class.

B. Sawing Equipment. Sawing equipment shall be a concrete saw capable of sawing concrete to the specified depth.

C. Hydraulic Impact Equipment. Hydraulic Impact/Skid Steer Type Equipment with a maximum rated striking Energy of 360 ft-lbs are permitted only in areas of concrete removal more than 6 inches away from boundaries of surface areas to remain in service. The Contractor is to provide data information to the engineer on the equipment they wish to utilize to ensure compliance with this note.

4. CONSTRUCTION.

- A. Remove Existing Materials.** Remove existing expansion joints, existing modular expansion joint assembly, bridge end armored edges and specified areas of concrete as shown on the attached detailed drawings. Remove debris and/or expansion joint filler as directed by the Engineer. Clean and leave all existing steel reinforcement encountered in place. Damaged steel reinforcement will be repaired/replaced as directed by the Engineer at no additional cost to the Department. Dispose of all removed material entirely away from the job site. This work is incidental to the contract unit price for "Expansion Joint Replacement" or "Armored Edge for Concrete".
- B. Place New Concrete and Armored Edges.** After all specified existing materials have been removed; place new armored edges to match the original grade (See attached detail drawings). Place the new Class "M" concrete to the original grade and finish with broom strokes drawn transversely from curb to curb. All new structural steel shall be cleaned and painted in accordance with requirements of Section 607.03.23, except that surfaces to come in contact with concrete are not to be painted. Blast clean all areas of existing concrete and structural steel to come in contact with new concrete until free of all laitance and deleterious substances immediately prior to the placement of the Class "M" Concrete. The surface areas of existing concrete to come in contact with the new Class "M" Concrete are to be coated with an epoxy bond coat immediately prior to placing new concrete in accordance with Section 511. The interfaces of the new and old concrete shall be as nearly vertical and horizontal as possible. Shop drawings will not be required.
- C. Additional Steel Reinforcement.** Furnish for replacement, as directed by the Engineer, 200 linear feet for each joint of #4 steel reinforcing bars in 20' lengths. Place these bars in areas deemed by the Engineer to require additional reinforcement. Field cutting and bending is permitted. Do not place any additional steel reinforcement above the height of the top row of Nelson Studs on the armored edges. Ensure that all exposed steel reinforcement is tied in accordance with Section 602.03.04 prior to pouring the new Class "M" concrete. Deliver unused bars to the Local County Maintenance Barn. Payment will be made in accordance with Section 602.
- D. Stage Construction.** Installation of concrete, armored edges and modular expansion joint assembly in two (or more if specified) stages is necessary. Join the armored edges and modular expansion joint assembly at or near the centerline of the roadway or lane line, field weld and grind smooth.
- E. Joint Seals.** Place joint seals as recommended by the manufacturer. Shop drawings will not be required.
- F. Verifying Field Conditions.** The Contractor shall field verify all joint openings, locations and manufacture before ordering any material. New material that is unsuitable due to variation in existing structure shall be replaced at the Contractors expense.
- G. Approach Pavement Repair.** The Contractor shall repair any and all damage to the approach pavement due to this construction. A new asphalt surface wedge for all approaches to each structure in this project shall be placed and compacted to the satisfaction of the Engineer prior to allowing traffic back onto the structure after each section of the joint is replaced. No additional payment will be allowed for this work, as it will be considered incidental to the pay item "Armored Edge for Concrete".

5. MEASUREMENT.

- A. Expansion Joint Replace 1 ½” In.** The Department will measure the quantity in linear feet from gutter line to gutter line along the centerline of the joint.
- B. Expansion Joint Replace 2” In.** The Department will measure the quantity in linear feet from gutter line to gutter line along the centerline of the joint.
- C. Expansion Joint Replace 2 ½” In.** The Department will measure the quantity in linear feet from gutter line to gutter line along the centerline of the joint.
- D. Expansion Joint Replace 4 In.** The Department will measure the quantity in linear feet from gutter line to gutter line along the centerline of the joint.
- E. Armored Edge for Concrete.** The Department will measure the quantity in linear feet from gutter line to gutter line along the face of the bridge end.
- F. Steel Reinforcement.** See Section 602.

6. PAYMENT.

- A. Expansion Joint Replace 1 ½” In. (03294)** Payment at the contract unit price per linear foot is full compensation for removing specified existing materials, furnishing and installing the new armored edges, concrete, joint seal, and all incidental items necessary to complete the work within the specified pay limits as specified by this note and as shown on the attached detail drawings.
- B. Expansion Joint Replace 2 In. (03295)** Payment at the contract unit price per linear foot is full compensation for removing specified existing materials, furnishing and installing the new armored edges, concrete, joint seal, and all incidental items necessary to complete the work within the specified pay limits as specified by this note and as shown on the attached detail drawings.
- C. Expansion Joint Replace 2 ½” In. (03296)** Payment at the contract unit price per linear foot is full compensation for removing specified existing materials, furnishing and installing the new armored edges, concrete, joint seal, and all incidental items necessary to complete the work within the specified pay limits as specified by this note and as shown on the attached detail drawings.
- D. Expansion Joint Replace 4 In. (03298)** Payment at the contract unit price per linear foot is full compensation for removing specified existing materials, furnishing and installing the new armored edges, concrete, neoprene strip seal, Pre-compressed Silicone and Foam Hybrid Seals and all incidental items necessary to complete the work within the specified pay limits as specified by this note and as shown on the attached detail drawings.
- E. C. Armored Edge for Concrete (03299).** Payment at the contract unit price per linear foot is full compensation for placing new armored edge and any approach pavement repair, traffic striping repair and all incidental items necessary to complete the work within the specified pay limits as specified by this note and as shown on the attached detailed drawings.
- F. Steel Reinforcement (08150).** See Section 602.

Residual lead paint may still be on bridge. The Contractor is advised to take all necessary protective measures including worker safety and environmental regulations. The Department will not consider any claims based on residual lead paint

SPECIAL NOTE FOR ELIMINATING TRANSVERSE JOINTS ON BRIDGES

- 1. DESCRIPTION.** Perform all work in accordance with the Kentucky Transportation Cabinet, Department of Highway's Standard Specifications for Road and Bridge Construction and applicable Supplemental Specifications, the Standard Drawings (Current Editions), this Note, and the Attached Detailed Drawings. Section references are to the Standard Specifications. This work consists of the following: (1) Furnish all labor, materials, tools, and equipment; (2) Remove existing concrete and expansion device(s) (3) Place new concrete and steel reinforcement as specified (4) Maintain and control traffic; and (5) Any other work specified as part of this contract. See attached detailed drawings.
- 2. MATERIALS.**
 - A. Class "M" Concrete.** Use either "M1" or "M2". See Section 601.
 - B. Steel Reinforcement.** Use Grade 60. See Section 602.
 - C. Epoxy Bond Coat.** See Section 511.
- 3. EQUIPMENT.**
 - A. Hammer.** See Section 606.02.10 B.
 - B. Sawing Equipment.** See Section 606.02.10 C.
 - C. Hydraulic Impact Equipment.** See Section 606.02.10 D.
- 4. CONSTRUCTION.**
 - A. Remove Existing Materials.** Remove the existing transverse joints, joint filler, and specified areas of concrete as shown on the plans or as directed by the Engineer. Clean and leave all existing steel reinforcement encountered in place. Damaged steel reinforcement will be repaired/replaced as directed by the Engineer at no additional cost to the Department.
Dispose of all removed material entirely away from the job site. This work is incidental to the contract unit price for "Eliminate Transverse Joint".
 - B. Additional Coated Steel Reinforcement.** Furnish for this work steel reinforcing bars as shown on the plans. Splice these bars to the existing longitudinal reinforcement in the deck and curb/sidewalk in the areas of removed concrete to tie the slabs together as shown on the plans. Ensure that all exposed steel reinforcement is tied in accordance with Section 602.03.04 prior to pouring the new Class "M" concrete.
 - C. Place New Concrete.** Blast-clean all areas of existing concrete and structural steel to come in contact with new concrete until free of all laitance and deleterious substances immediately prior to the placement of the Class "M" Concrete. The surface areas of existing concrete to come in contact with the new Class "M" Concrete are to be coated with an epoxy bond coat immediately prior to placing new concrete in accordance with Section 511. The interfaces of the new and old concrete shall be as nearly vertical and horizontal as possible. Place new Class "M" Concrete to the specified grade and finish to receive the new overlay or as shown on the plans. On the sidewalk and curb, place the new concrete to original grade and finish to match the existing curb/sidewalk. Repair all pavement striping that is disturbed.
 - D. Stage Construction.** Installation of concrete in two (or more if specified) stages is necessary.
 - E. Residual Lead.** Residual lead paint may still be on bridge. The Contractor is advised to take all necessary protective measures including worker safety and

environmental regulations when performing surface preparation. The Department will not consider any claims based on residual lead paint.

F. Verifying Field Conditions. The Contractor shall field verify all dimensions before ordering any material. New material that is unsuitable due to variation in existing structure shall be replaced at the Contractors expense.

G. Damage to the Structure. The Contractor shall bear all responsibility and expense for any and all damage to the structure during the repair work even to removal and replacement of a fall span, should the fallen span result from the Contractor's actions.

5. MEASUREMENT.

A. Eliminate Transverse Joint. The Department will measure the quantity in linear feet from plinth to plinth perpendicular to the centerline of the bridge.

B. Steel Reinforcement. See Section 602.

6. PAYMENT.

A. Eliminate Transverse Joint (03300). Payment at the contract unit price per linear foot is full compensation for furnishing equipment, labor, tools and materials needed to complete removal and disposal of the specified existing materials, cleaning and straightening of existing steel reinforcement, furnishing and installing the concrete, repairing traffic striping and all incidental items necessary to complete the work within the specified pay limits as specified by this note and as shown on the attached detail drawings.

B. Steel Reinforcement (08150). See Section 602.

SPECIAL NOTE FOR MAINTAIN AND CONTROL TRAFFIC

All lane closures on this project shall be in accordance with Kentucky Department of Highways Standard Drawings **No. TTC 115, TTC 135 and the FHWA Manual for Uniform Traffic Control Devices (Current Editions) unless otherwise specified.** Lane closures should be used only when absolutely necessary and kept to the shortest duration possible in order to minimize disruption to the traveling public. No work will be conducted over unprotected traffic at any location. At the discretion of the Engineer, lane closures may be restricted on holiday weekends.

The contractor shall be required to submit in writing, to the department, his complete work schedule 14 days prior to the Pre-Construction Conference. The contractor shall be required to coordinate his efforts with those of any other contractor in the construction area so as to eliminate any lane closures which conflict with this traffic note.

In the event it becomes necessary to make emergency repairs at this project by state forces or by other outside contractors, the (painting) contractor shall agree to alter his work pattern as directed by the engineer so as not to interfere with the emergency work.

The contractor shall be required to furnish all traffic control devices whenever his operations endanger or interfere with vehicular traffic as determined by the engineer. The contractor shall furnish any additional traffic control devices necessary to protect traffic and his workmen. Any costs associated with the added traffic control devices (including arrow boards) shall be incidental to the contract lump sum amount for "maintain and control traffic."

Placement of all devices for lane closures shall start and proceed in the direction of flow of traffic. Removal of devices shall start at the end of the construction area and proceed toward oncoming traffic. The contractor shall provide for the installation of all necessary traffic control devices before beginning work and their immediate removal as soon as work is suspended or completed. During the fully operational periods, when no lane closures are permitted, all equipment shall be totally removed from the job site. Traffic control signs shall be removed or covered (if left in a curb lane).

The contractor's vehicles shall always move with and not across or against the flow of traffic. Vehicles shall enter or leave work areas in a manner that will not be hazardous to or interfere with normal roadway traffic. Vehicles shall not park or stop except within designated work areas.

Personal vehicles shall not be permitted to park within the state right-of-way. The contractor's vehicles shall be prohibited from crossing the roadway and all pedestrian movement of the contractor's personnel on the roadway shall be limited to within the closed work area.

All Bridges

Maintain a 12'-0" usable lane each direction on US 25E. Shoulder closures may be used. All lane closures and shoulder closures must be removed when not working. Lane closures for will be permitted to stay in place for the expansion joint replacement work if required for that bridge.

MEASUREMENT.

A. Maintain and Control Traffic: The Department will measure the quantity by Lump Sum, completed and accepted.

PAYMENT.

A. Maintain and Control Traffic (02650). Payment of the contract lump sum amount for "maintain and control traffic" shall be full compensation for all items necessary to maintain and control traffic as specified for this project. All traffic control items shall remain the property of the contractor when the work is complete.

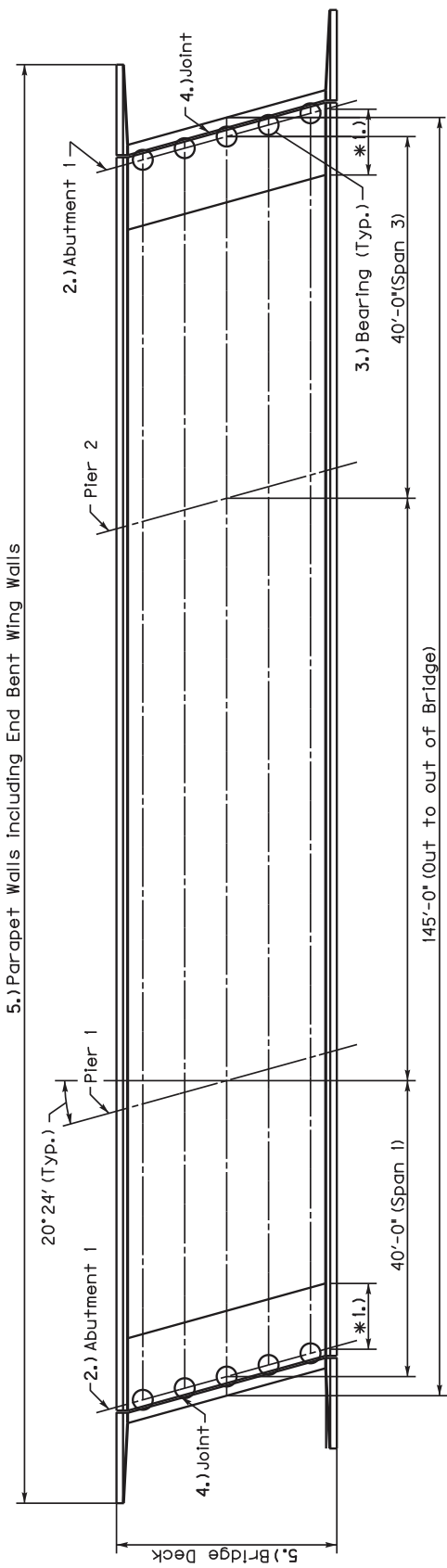

BRIDGE PLAN
(Typ. Each Bridge)
38'-6"

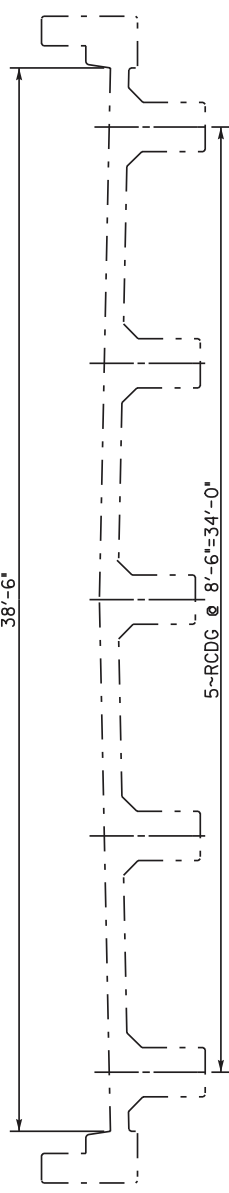

TYPICAL SECTION
(Typ. Each Bridge)

- 1.) * 10'-0"~Remove debris and pressure wash all beam end and diaphragm surfaces in this limit.
* 4'-0"~Apply concrete coating to all beam end and diaphragm surfaces in this limit. See Concrete Coating Diagram.
- 2.) Remove debris, pressure wash then apply concrete coating to surfaces at each abutment. See Concrete Coating Diagram.
- 3.) ○ Indicates bearing device. Remove debris, stratified and pack rust, pressure wash and lubricate. 10 each bridge, 20 total.
- 4.) Remove debris and pressure wash joints as shown in bridge plan 2 each bridge, 4 total.
- 5.) Remove debris and pressure wash and then apply sealant to the bridge deck and inside faces and top of parapets the entire length of the bridge including the abutment wingwalls. See Social Note for Bridge Cleaning and Preventative Maintenance for additional information.

BRIDGE NO.
063B00058L
063B00058R

121GR18M067

Commonwealth of Kentucky DEPARTMENT OF HIGHWAYS
LAUREL - KNOX - BELL
LAYOUT
PREPARED BY Division of Maintenance Bridge Preservation Branch

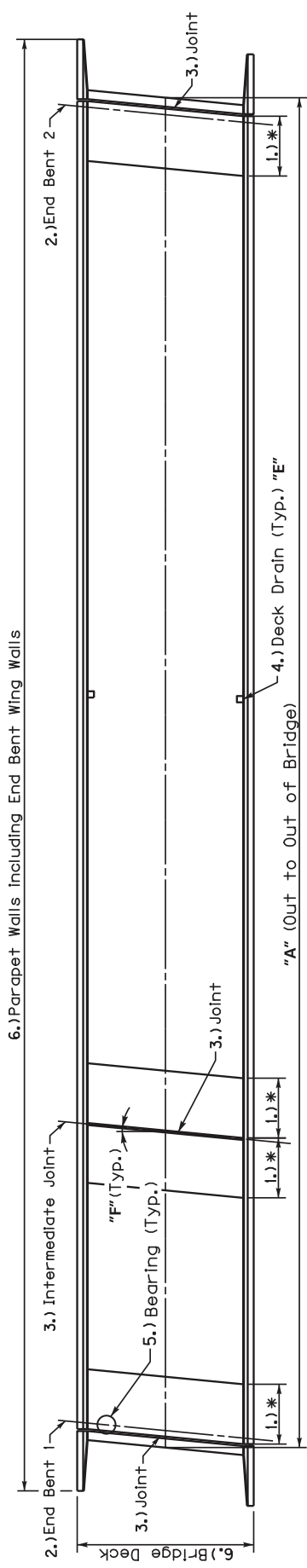

BRIDGE PLAN

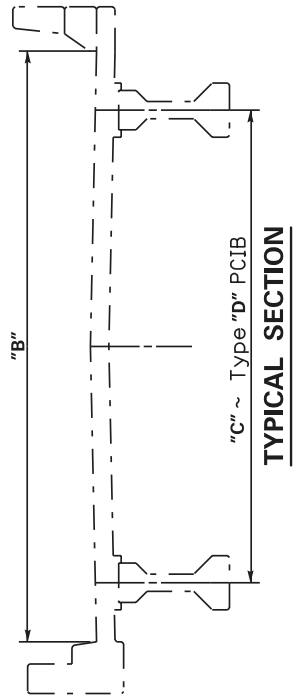

121GR18M067

Commonwealth of Kentucky DEPARTMENT OF HIGHWAYS
COUNTY LAUREL - KNOX - BELL
LAYOUT
PREPARED BY Division of Maintenance Bridge Preservation Branch

- 1.) * 10'-0"~Remove debris and pressure wash all beam end and diaphragm surfaces in this limit.
* 4'-0"~Apply concrete coating to all beam end and diaphragm surfaces in this limit. See Concrete Coating Diagram.
Applies to End Bent/Abut. 007B00026N, 007B00131L&R, 061B00089L&R, 061B00082R & 061B00081R.
Applies to Piers with open joint above, 007B00131L&R and 007B00130L&R
- 2.) Remove debris, pressure wash then apply concrete coating to surfaces at each abutment.
See Concrete Coating Diagram.
Applies to End Bent/Abut. 007B00026N, 007B00131L&R, 061B00089L&R, 061B00082R & 061B00081R.
Applies to Piers with open joint above, 007B00131L&R and 007B00130L&R
- 3.) Clean: Remove debris and pressure wash joints. See joint data table for bridges to receive this work. See Special note for Bridge Cleaning and Preventive Maintenance.

Reseal: Remove existing joint seal and replace. See Joint Data table for bridges to receive this work. See special note for joint seal replacement.

Replace: Remove existing expansion joint assembly and replace. See Joint Data table for bridges to receive this work. See special note for replacing expansion joints and/or installing armored edges for concrete on bridges.

4.) Remove debris and pressure wash deck drains as shown in bridge plan. See Bridge Information Table, Item "E" for quantity.

5.) O Indicates bearing device. Remove debris, stratified and pack rust, pressure wash and lubricate. 20 total. Applies to 007B00026N only.

6.) Remove debris, pressure wash and then apply sealant to the bridge deck and inside faces and top of parapets the entire length of the bridge including the abutment wingwalls.
See Special Note for Bridge Cleaning and Preventative Maintenance for additional information.

BRIDGE INFORMATION TABLE

BRIDGE NO.	"A"	"B"	"C"	"D"	"E"	"F"
007B00026N	162'-0"±	74'-0"	10	2	8	00°00'00"
007B00130L	131'-0"±	40'-0"	6	4/4 (Mod)	34	Varies
007B00130R	131'-0"±	40'-0"	6	4/4 (Mod)	34	Varies
007B00131L	1020'-0"±	40'-0"	6	4/4 (Mod)	14	20°00'00"LT
007B00131R	1020'-0"±	40'-0"	6	4/4 (Mod)	14	20°00'00"LT
061B00089R	433'-0"±	40'-0"	6	4	16	15°00'00"RT
061B00089L	433'-0"±	40'-0"	6	4	16	15°00'00"RT
061B00090R	236'-0"±	40'-0"	6	4 (Mod)	4	45°00'00"RT
061B00090L	236'-0"±	40'-0"	6	4	4	45°00'00"RT
061B00091N	304'-0"±	40'-0"	6	4	12	30°00'00"LT
061B00091L	304'-0"±	40'-0"	6	4	12	30°00'00"LT
061B00092R	193'-0"±	40'-0"	5	3	4	00°00'00"
061B00092L	193'-0"±	40'-0"	5	3	4	00°00'00"
061B00082R	223'-0"±	40'-0"	6	4	14	30°00'00"LT
061B00081R	162'-0"±	40'-0"	6	2	12	00°00'00"

JOINT DATA

BRIDGE NO.	END BENT/ABUT. 1	PIER	END BENT/ABUT. 2
007B00026N	Clean	N/A	Clean
007B00130L	Clean	Reseal ~ 2", 3 Total	Clean
007B00130R	Clean	Reseal ~ 2", 3 Total	Clean
007B00131L	Replace ~ 4" & 2/2"	Replace ~ 4"	Replace ~ 4" & 2/2"
007B00131R	Replace ~ 4" & 2/2"	Replace ~ 4"	Replace ~ 4" & 2/2"
061B00089L	Replace ~ 4"	N/A	Replace ~ 4"
061B00089R	Replace ~ 4"	N/A	Replace ~ 4"
061B00090L	N/A	N/A	N/A
061B00090R	N/A	N/A	N/A
061B00091L	Clean	N/A	Clean
061B00091R	Clean	N/A	Clean
061B00092L	Clean	N/A	Clean
061B00092R	Clean	N/A	Clean
061B00082R	Reseal ~ 2"	N/A	Reseal ~ 2"
061B00081R	Replace ~ 2/2"	N/A	Replace ~ 2/2"

121GR18M067

Commonwealth of Kentucky DEPARTMENT OF HIGHWAYS
COUNTY LAUREL - KNOX - BELL
LAYOUT
PREPARED BY Division of Maintenance Bridge Preservation Branch

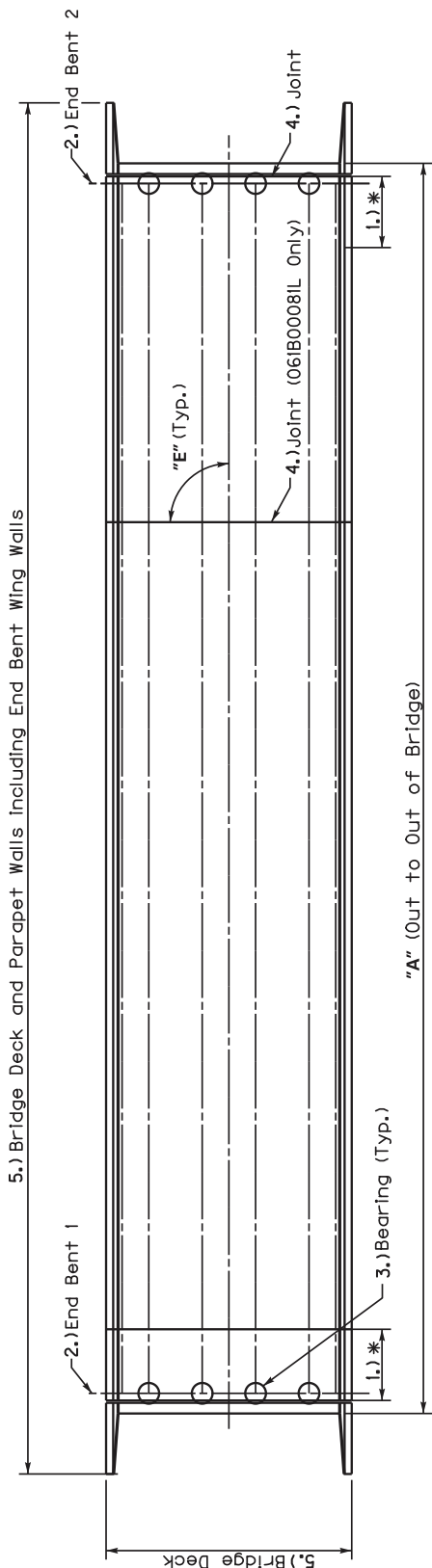

"A" (Out to Out of Bridge)

BRIDGE PLAN

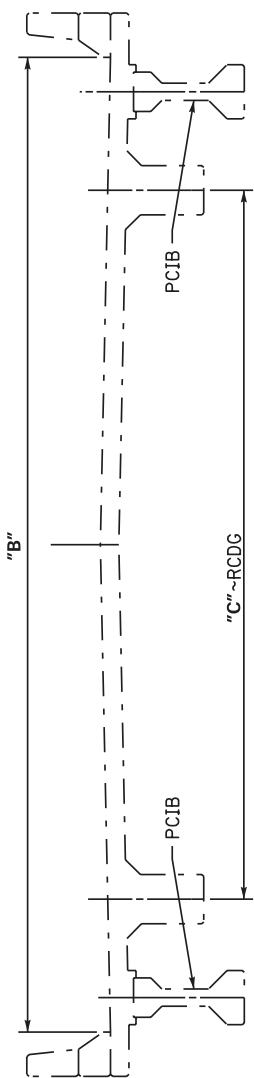

TYPICAL SECTION

BRIDGE INFORMATION TABLE				
BRIDGE NO.	"A"	"B"	"C"	"E"
06IB00082L	223'-0"±	40'-0"	4	12
06IB00081L	162'-0"±	40'-0"	6	12
				30° 00' 00" LT
				00° 00' 00" R

JOINT DATA			
BRIDGE NO.	END BENT/ABUT. 1	PIER	END BENT/ABUT. 2
06IB00082L	Reseal ~ 1"	N/A	Reseal ~ 2"
06IB00081L	N/A	Eliminate	N/A

- 1.) * 10'-0"~Remove debris and pressure wash all beam end and diaphragm surfaces in this limit.
* 4'-0"~Apply concrete coating to all beam end and diaphragm surfaces in this limit. See Concrete Coating Diagram. Applies to 06IB00082L only.
- 2.) Remove debris, pressure wash then apply concrete coating to surfaces at each abutment. See Concrete Coating Diagram. Applies to 06IB00082L only.
- 3.) ○ Indicates bearing device. Remove debris, stratified and pack rust, pressure wash and lubricate, 8 total. Applies to 06IB00082L only.
- 4.) Eliminate transverse joint. See Special Note for Eliminating Transverse Joints on Bridges
Reseal: Remove each existing joint seal and replace. See special note for joint seal replacement.
- 5.) Remove debris and pressure wash and then apply sealant to the bridge deck and inside faces and top of parapets the entire length of the bridge including the abutment wingwalls. See Social Note for Bridge Cleaning and Preventative Maintenance for additional information.

121GR18M067

Commonwealth of Kentucky DEPARTMENT OF HIGHWAYS
COUNTY LAUREL - KNOX - BELL
LAYOUT
PREPARED BY Division of Maintenance Bridge Preservation Branch

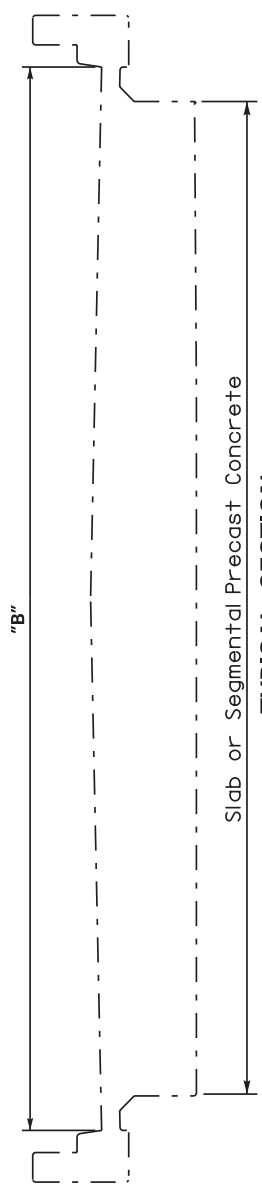
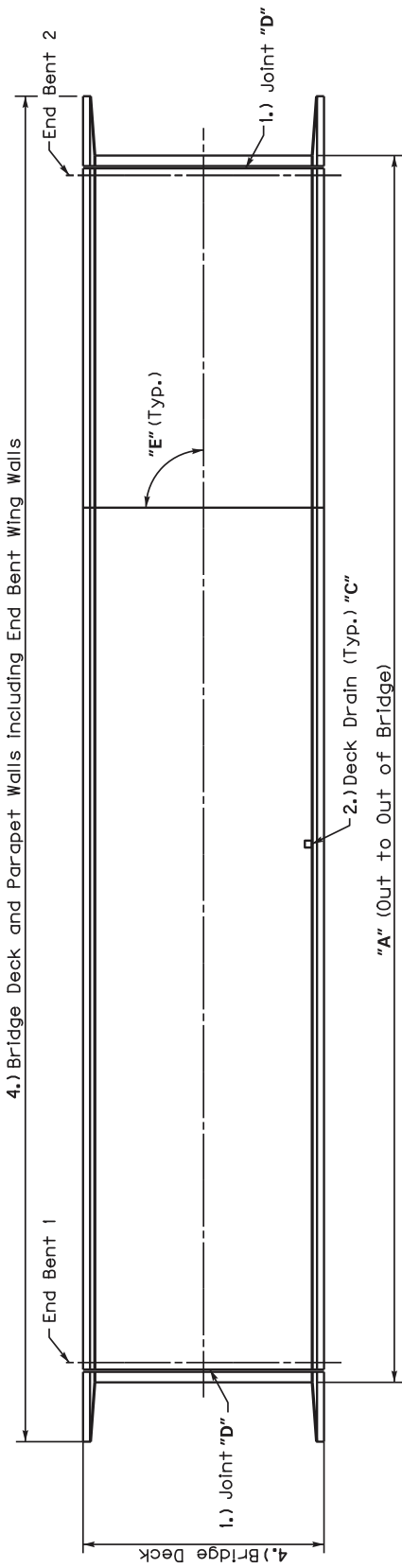

BRIDGE INFORMATION TABLE

BRIDGE NO.	"A"	"B"	"C"	"D"	"E"
007B00136L	118'-0"±	43'-0"	0	2	32° 00'00"RT
007B00136R	118'-0"±	43'-0"	0	1	32° 00'00"RT
007B00137N	169'-0"±	45'-0"	0	1	00° 00'00"
007B00126N	44'-0"±	76'-0"	5	1	00° 00'00"

- 1.) Remove debris and pressure wash joints as shown in bridge plan. See Bridge Information Table, Item "D" for quantity
- 2.) Remove debris and pressure wash deck drains as shown in bridge plan. See Bridge Information Table, Item "C" for quantity.
- 3.) Remove existing joint seal and replace 2". Applies to each joint for 007B00126N only. See special note for joint seal replacement.
- 4.) Remove debris and pressure wash and then apply sealant to the bridge deck and inside faces and top of parapets the entire length of the bridge including the abument wingwalls. See Social Note for Bridge Cleaning and Preventative Maintenance for additional information.

121GR18M067

Commonwealth of Kentucky DEPARTMENT OF HIGHWAYS
COUNTY LAUREL - KNOX - BELL
LAYOUT
PREPARED BY Division of Maintenance Bridge Preservation Branch

END BENTS/ABUTMENTS:
Surfaces of the end bents/abutments shall have debris removed, pressure washed and have concrete coating applied as specified, this includes ALL horizontal surfaces of the cap and ALL vertical surfaces to 1 foot below the top of cap or to the ground line whichever is the least including ALL pedestals and the front face end wall.

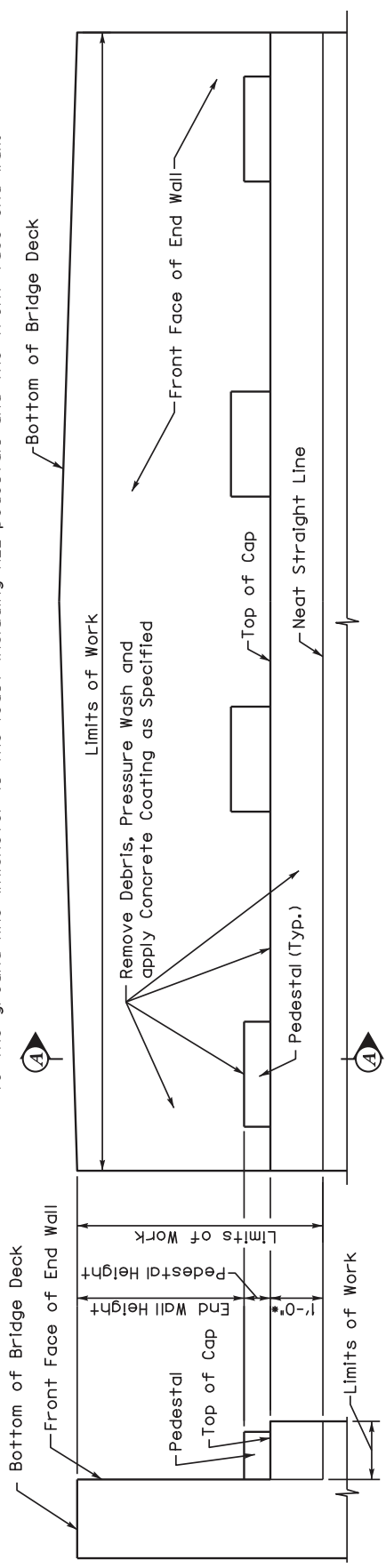

SECTION A-A

*1 foot below the top of cap or to the ground line whichever is the least.

END BENT/ABUTMENT ELEVATION

PIERS:
Surfaces of the end bents/abutments shall have debris removed, pressure washed and have concrete coating applied as specified, this includes ALL horizontal surfaces of the cap and ALL vertical surfaces to 1 foot below the top of cap including ALL pedestals.



SECTION B-B

PIER ELEVATION

121GR18M067

Commonwealth of Kentucky DEPARTMENT OF HIGHWAYS
COUNTY LAUREL - KNOX - BELL
CONCRETE COATING DIAGRAM
PREPARED BY Division of Maintenance Bridge Preservation Branch

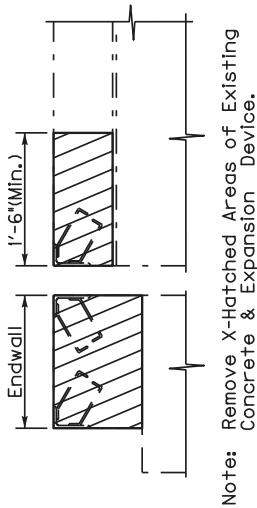

SECTION THROUGH JOINT
(Existing)

Note: See Special Note for Replacing Expansion Dams and/or Installing Armored Edges for Concrete on Bridges

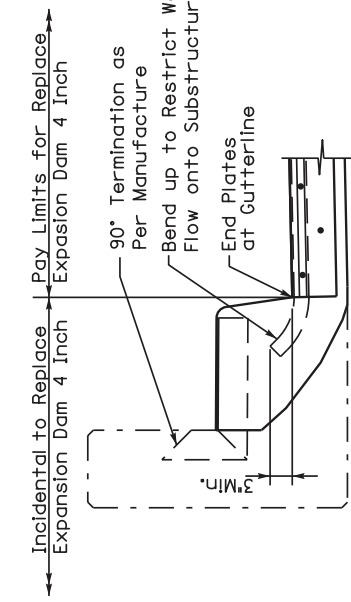

SECTION THROUGH PARAPET
(Proposed, Plinth Type)

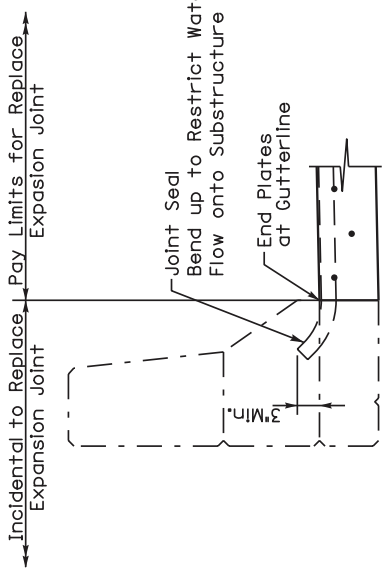

SECTION THROUGH PARAPET
(Proposed, Barrier Type)

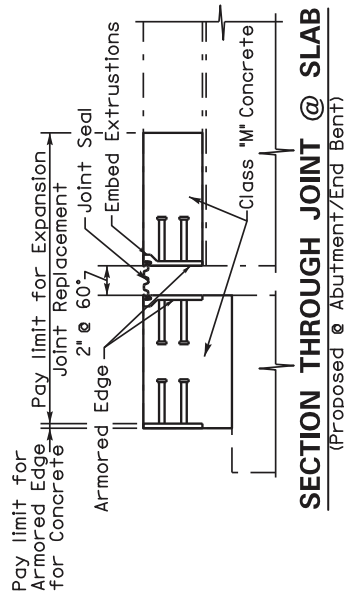

SECTION THROUGH JOINT @ SLAB
(Proposed @ Abutment/End Bent)

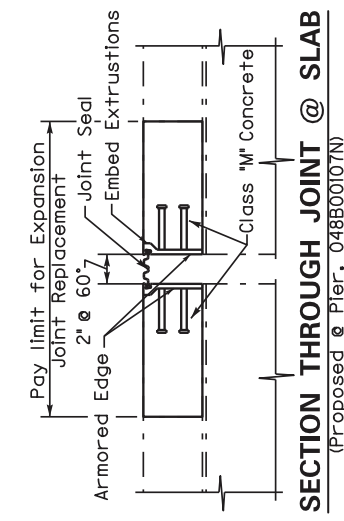

SECTION THROUGH JOINT @ SLAB
(Proposed @ Pier, 048B00107N)

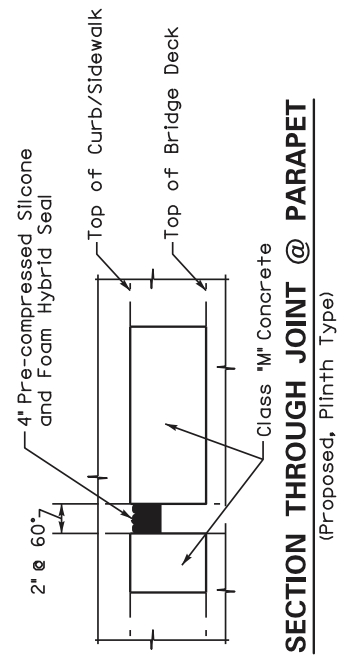

SECTION THROUGH JOINT @ PARAPET
(Proposed, Plinth Type)

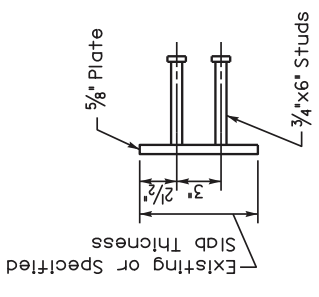
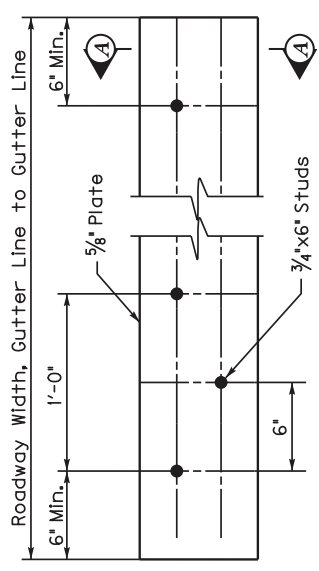

SECTION A-A

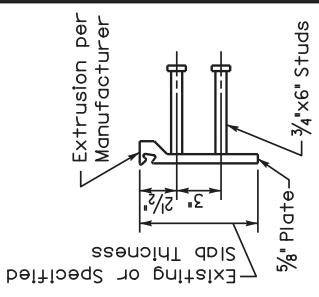
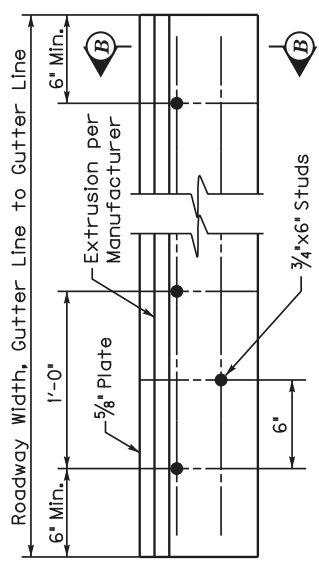

SECTION B-B

121GR18M067

Commonwealth of Kentucky
DEPARTMENT OF HIGHWAYS

COUNTY
LAUREL - KNOX - BELL

REPLACE EXPANSION JOINT 4"

PREPARED BY
Division of Maintenance
Bridge Preservation Branch

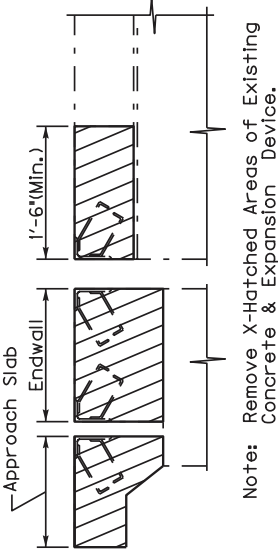

SECTION THROUGH JOINT
(007B00131L&R @ End Bent, Existing)

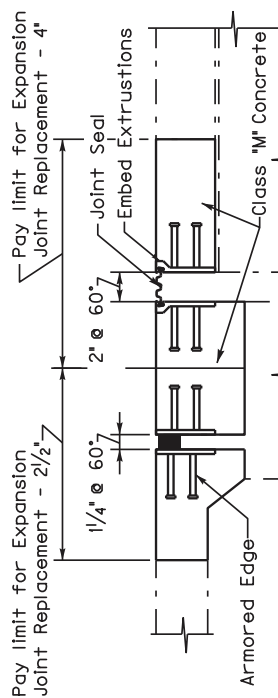

SECTION THROUGH JOINT @ SLAB
(007B00131L&R @ End Bent, Proposed)

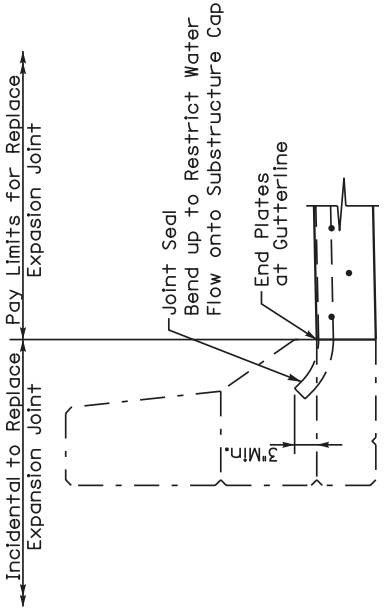

SECTION THROUGH PAPAPEI
(Proposed, Barrier Type)

Note: See Special Note for Replacing Expansion Dams and/or Installing Armored Edges for Concrete on Bridges

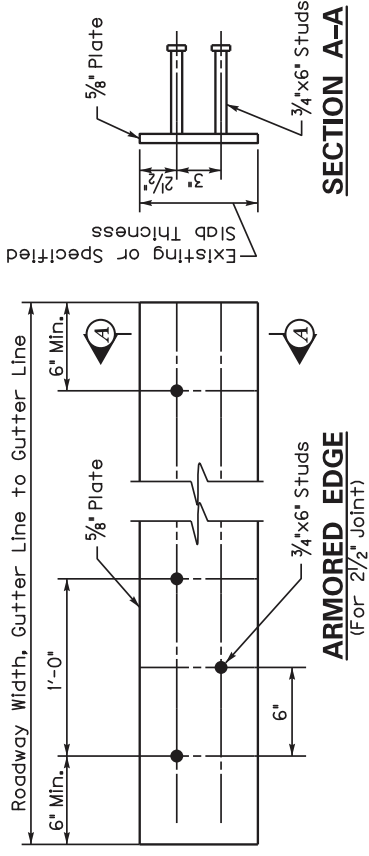

121GR18M067

Commonwealth of Kentucky DEPARTMENT OF HIGHWAYS
COUNTY LAUREL - KNOX - BELL
REPLACE EXPANSION JOINT 2 1/2" & 4"
PREPARED BY Division of Maintenance Bridge Preservation Branch

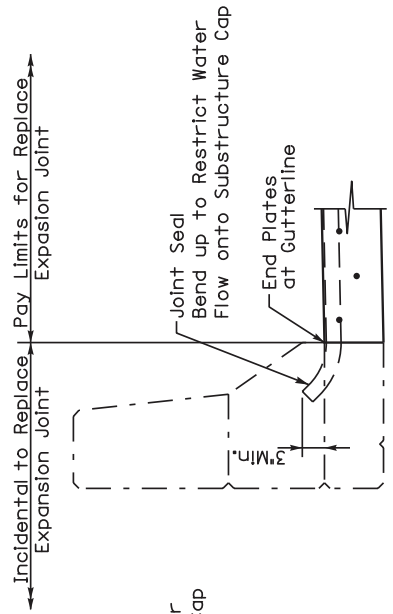

SECTION THROUGH PAPAPET
(Proposed, Barrier Type)

DIMENSION A	
JOINT SIZE	* @ 60°
1 1/2"	3/4"
2"	1"
2 1/2"	1 1/4"

Note: See Special Note for Replacing Expansion Dams and/or Installing Armored Edges for Concrete on Bridges

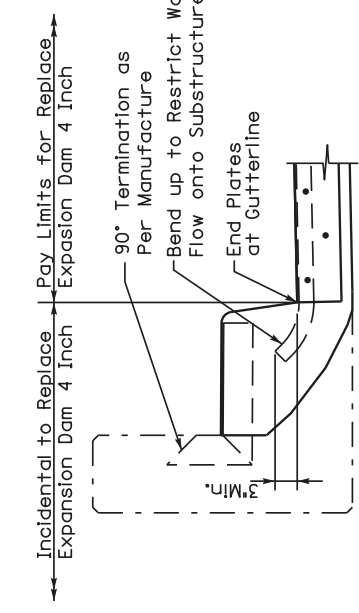

SECTION THROUGH PARAPET
(Proposed, Plinth Type)

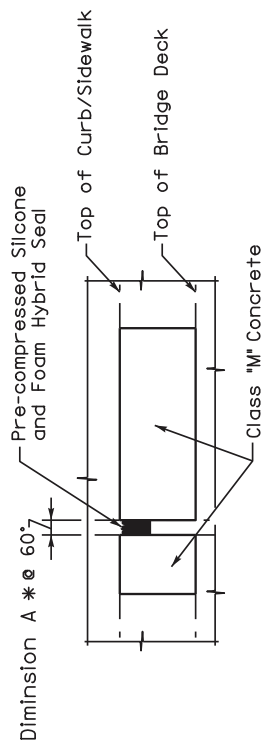

SECTION THROUGH JOINT @ PARAPET
(Proposed, Plinth Type)

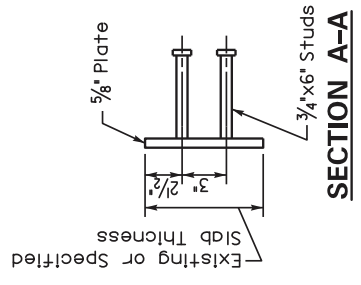

SECTION A-A

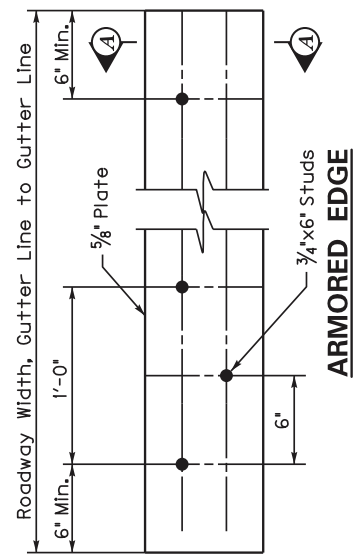
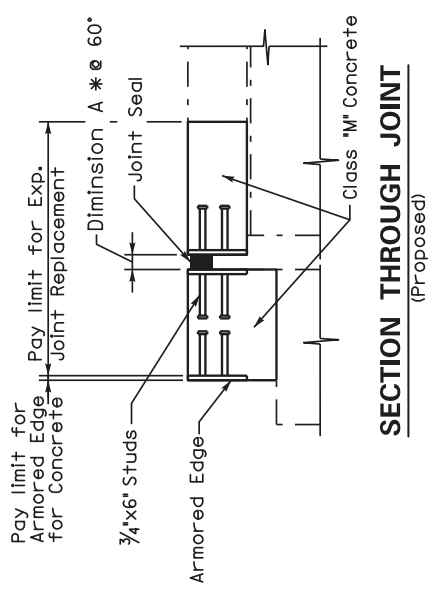
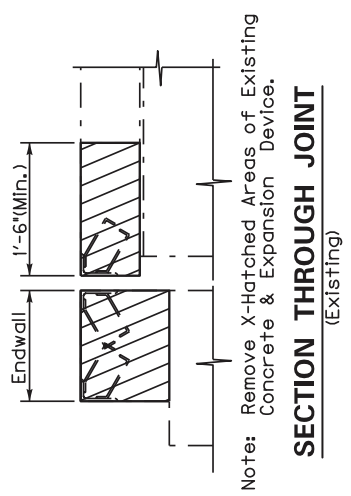

121GR18M067

Commonwealth of Kentucky DEPARTMENT OF HIGHWAYS
COUNTY LAUREL - KNOX - BELL
REPLACE EXPANSION JOINT 1 12"-2 12"
PREPARED BY Division of Maintenance Bridge Preservation Branch

SPECIAL NOTE FOR CONTRACT COMPLETION DATE AND LIQUIDATED DAMAGES ON BRIDGE REPAIR CONTRACTS

- I. COMPLETION DATE.** The Contractor has the option of selecting the starting date for this Contract. Once selected, notify the Department in writing of the date selected at least two weeks prior to beginning work. All work is to be completed by November 15, 2019.

Contrary to Section 108.07.02, the Engineer will begin charging calendar days for a structure on the day the Contractor starts work or sets up traffic control on that particular structure.

- II. LIQUIDATED DAMAGES.** Liquidated damages will be assessed the Contractor in accordance with the Transportation Cabinet, Department of Highway's 2012 Standard Specifications for Road and Bridge Construction, Section 108.09, when the November 15, 2019 date is exceeded.

Contrary to the Standard Specifications, liquidated damages will be assessed the Contractor during the months of December, January, February and March when the contract time has expired on any individual bridge or bridges. Contract time will be charged during these months.

All construction must be completed in accordance with the weather limitations specified in Section 606 and/or Section 601 as applicable. No extension of Contract time will be granted due to inclement weather or temperature limitations that occur due to starting work on the Contract or a structure late in the construction season.

US25E - LAUREL, KNOX, AND BELL COUNTIES

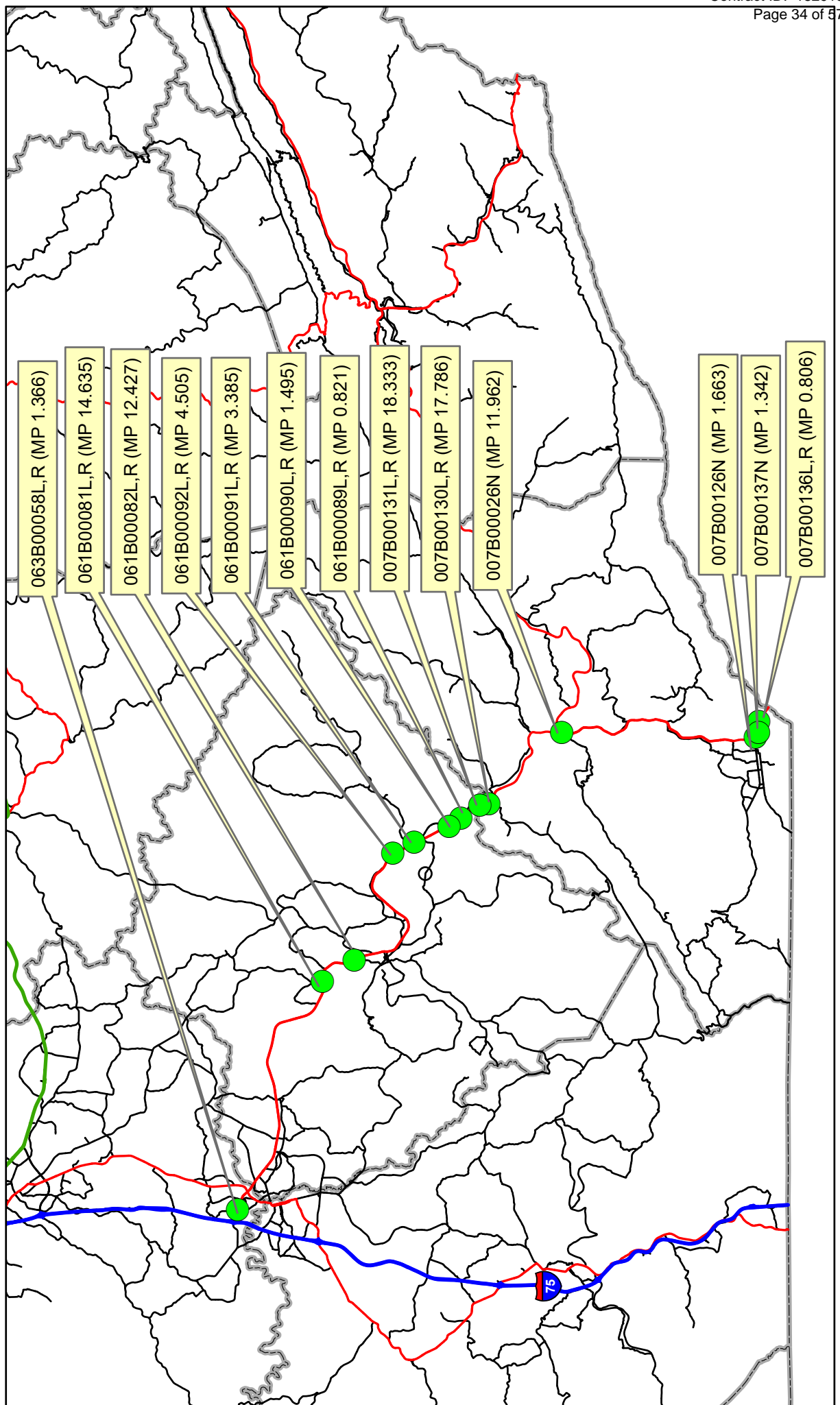
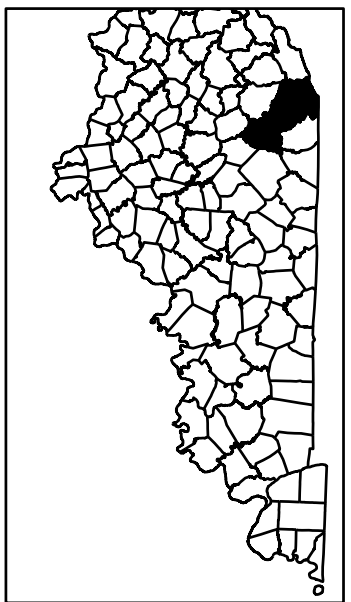

MATERIAL SUMMARY

CONTRACT ID: 182913

121GR18M081-FD04

MB00700251801

US 25E (MP 18.333). BRIDGE OVER OLD 25E AND CUMBERLAND RIVER. BRIDGE REPAIRS EXPANSION JOINTS.

Project Line No	Bid Code	DESCRIPTION	Quantity	Unit
0355	02650	MAINTAIN & CONTROL TRAFFIC - APPLIES TO 007B00131L	1.00	LS
0360	03296	EXPAN JOINT REPLACE 2 1/2 IN	85.10	LF
0365	03298	EXPAN JOINT REPLACE 4 IN	127.70	LF
0370	24981EC	BRIDGE CLEANING - APPLIES TO 007B00131L	1.00	LS
0375	24982EC	CONCRETE COATING - APPLIES TO 007B00131L	1.00	LS
0380	02569	DEMOBILIZATION	1.00	LS
0385	24439EC	SEAL BRIDGE DECK	1.00	LS
0390	02650	MAINTAIN & CONTROL TRAFFIC - APPLIES TO 007B00131R	1.00	LS
0395	03296	EXPAN JOINT REPLACE 2 1/2 IN	85.10	LF
0400	03298	EXPAN JOINT REPLACE 4 IN	127.70	LF
0405	24439EC	SEAL BRIDGE DECK	1.00	LS
0410	24981EC	BRIDGE CLEANING - APPLIES TO 007B00131R	1.00	LS
0415	24982EC	CONCRETE COATING - APPLIES TO 007B00131R	1.00	LS
0420	08150	STEEL REINFORCEMENT	1,336.00	LB

CONTRACT ID: 182913

121GR18M081-FD04

MB00700251802

US 25E (MP 17.786). BRIDGE OVER KY 2014 AND CUMBERLAND RIVER. BRIDGE REPAIRS EXPANSION JOINTS.

Project Line No	Bid Code	DESCRIPTION	Quantity	Unit
0425	02650	MAINTAIN & CONTROL TRAFFIC - APPLIES TO 007B00130L.	1.00	LS
0430	23386EC	JOINT SEAL REPLACEMENT	145.00	LF
0435	24981EC	BRIDGE CLEANING - APPLIES TO 007B00130L.	1.00	LS
0440	02569	DEMOBILIZATION	1.00	LS
0445	24439EC	SEAL BRIDGE DECK	1.00	LS
0450	02650	MAINTAIN & CONTROL TRAFFIC - APPLIES TO 007B00130R.	1.00	LS
0455	23386EC	JOINT SEAL REPLACEMENT	145.00	LF
0460	24439EC	SEAL BRIDGE DECK	1.00	LS
0465	24981EC	BRIDGE CLEANING - APPLIES TO 007B00130R.	1.00	LS
0470	24982EC	CONCRETE COATING - APPLIES TO 007B00130L (ADDED: 10-15-18)	1.00	LS
0475	24982EC	CONCRETE COATING - APPLIES TO 007B00130R (ADDED: 10-15-18)	1.00	LS

MATERIAL SUMMARY

CONTRACT ID: 182913

121GR18M081-FD04

MB00700251803

US 25E (MP 11.962). BRIDGE OVER CLEAR CREEK LANE. BRIDGE REPAIRS EXPANSION JOINTS.

Project Line No	Bid Code	DESCRIPTION	Quantity	Unit
0480	02650	MAINTAIN & CONTROL TRAFFIC - APPLIES TO 007B00026N	1.00	LS
0485	24981EC	BRIDGE CLEANING - APPLIES TO 007B00026N	1.00	LS
0490	24982EC	CONCRETE COATING - APPLIES TO 007B00026N	1.00	LS
0495	24983EC	BEARING LUBRICATION	20.00	EACH
0500	02569	DEMOBILIZATION	1.00	LS
0505	24439EC	SEAL BRIDGE DECK	1.00	LS

CONTRACT ID: 182913

121GR18M081-FD04

MB00700251806

US 25E (MP 1.663). BRIDGE OVER LITTLE YELLOW CREEK. BRIDGE REPAIRS EXPANSION JOINTS.

Project Line No	Bid Code	DESCRIPTION	Quantity	Unit
0510	02650	MAINTAIN & CONTROL TRAFFIC - APPLIES TO 007B00126N	1.00	LS
0515	23386EC	JOINT SEAL REPLACEMENT	152.00	LF
0520	24981EC	BRIDGE CLEANING - APPLIES TO 007B00126N	1.00	LS
0525	02569	DEMOBILIZATION	1.00	LS
0530	24439EC	SEAL BRIDGE DECK	1.00	LS

CONTRACT ID: 182913

121GR18M081-FD04

MB00700251807

US 25E (MP 1.342). SKYLAND DRIVE BRIDGE OVER US25E. BRIDGE REPAIRS EXPANSION JOINTS.

Project Line No	Bid Code	DESCRIPTION	Quantity	Unit
0535	02650	MAINTAIN & CONTROL TRAFFIC - APPLIES TO 007B00137N	1.00	LS
0540	02569	DEMOBILIZATION	1.00	LS
0545	24439EC	SEAL BRIDGE DECK	1.00	LS

MATERIAL SUMMARY

CONTRACT ID: 182913

121GR18M081-FD04

MB00700251808

US 25E (MP 0.806). US 25E OVER PINNACLE VIEW ROAD. BRIDGE REPAIRS EXPANSION JOINTS.

Project Line No	Bid Code	DESCRIPTION	Quantity	Unit
0550	02650	MAINTAIN & CONTROL TRAFFIC - APPLIES TO 007B00136L	1.00	LS
0555	02569	DEMOBILIZATION	1.00	LS
0560	24439EC	SEAL BRIDGE DECK	1.00	LS
0565	02650	MAINTAIN & CONTROL TRAFFIC - APPLIES TO 007B00136R	1.00	LS
0570	24439EC	SEAL BRIDGE DECK	1.00	LS

CONTRACT ID: 182913

121GR18M081-FD04

MB06100251801

US 25E (MP 14.635). BRIDGE OVER BIG RICHLAND CREEK. BRIDGE REPAIRS EXPANSION JOINTS.

Project Line No	Bid Code	DESCRIPTION	Quantity	Unit
0060	02650	MAINTAIN & CONTROL TRAFFIC - APPLIES TO 061B00081L	1.00	LS
0065	03300	ELIMINATE TRANSVERSE JOINT	40.00	LF
0070	24981EC	BRIDGE CLEANING - APPLIES TO 061B00081L	1.00	LS
0075	02569	DEMOBILIZATION	1.00	LS
0080	24439EC	SEAL BRIDGE DECK	1.00	LS
0085	02650	MAINTAIN & CONTROL TRAFFIC - APPLIES TO 061B00081R	1.00	LS
0090	24439EC	SEAL BRIDGE DECK	1.00	LS
0095	24981EC	BRIDGE CLEANING - APPLIES TO 061B00081R	1.00	LS
0100	24982EC	CONCRETE COATING - APPLIES TO 061B00081R	1.00	LS
0105	03299	ARMORED EDGE FOR CONCRETE	80.00	LF
0110	03296	EXPAN JOINT REPLACE 2 1/2 IN	80.00	LF
0115	24983EC	BEARING LUBRICATION	10.00	EACH
0120	24983EC	BEARING LUBRICATION	10.00	EACH

MATERIAL SUMMARY

CONTRACT ID: 182913

121GR18M081-FD04

MB06100251802

US 25E (MP 12.427). BRIDGE OVER LITTLE RICHLAND CREEK. BRIDGE REPAIRS EXPANSION JOINTS.

Project Line No	Bid Code	DESCRIPTION	Quantity	Unit
0125	02650	MAINTAIN & CONTROL TRAFFIC - APPLIES TO 061B00082L	1.00	LS
0130	23386EC	JOINT SEAL REPLACEMENT	93.00	LF
0135	24981EC	BRIDGE CLEANING - APPLIES TO 061B00082L	1.00	LS
0140	24982EC	CONCRETE COATING - APPLIES TO 061B00082L	1.00	LS
0145	24983EC	BEARING LUBRICATION	8.00	EACH
0150	02569	DEMOBILIZATION	1.00	LS
0155	02650	MAINTAIN & CONTROL TRAFFIC - APPLIES TO 061B00082R	1.00	LS
0160	23386EC	JOINT SEAL REPLACEMENT	93.00	LF
0165	24981EC	BRIDGE CLEANING - APPLIES TO 061B00082R	1.00	LS
0170	24982EC	CONCRETE COATING - APPLIES TO 061B00082R	1.00	LS
0175	24439EC	SEAL BRIDGE DECK	1.00	LS
0180	24439EC	SEAL BRIDGE DECK	1.00	LS

CONTRACT ID: 182913

121GR18M081-FD04

MB06100251803

US 25E (MP 4.505). BRIDGE OVER TURKEY CREEK. BRIDGE REPAIRS EXPANSION JOINTS.

Project Line No	Bid Code	DESCRIPTION	Quantity	Unit
0185	02650	MAINTAIN & CONTROL TRAFFIC - APPLIES TO 061B00092L	1.00	LS
0190	24981EC	BRIDGE CLEANING - APPLIES TO 061B00092L	1.00	LS
0195	02569	DEMOBILIZATION	1.00	LS
0200	24439EC	SEAL BRIDGE DECK	1.00	LS
0205	02650	MAINTAIN & CONTROL TRAFFIC - APPLIES TO 061B00092R	1.00	LS
0210	24439EC	SEAL BRIDGE DECK	1.00	LS
0215	24981EC	BRIDGE CLEANING - APPLIES TO 061B00092R	1.00	LS

MATERIAL SUMMARY

CONTRACT ID: 182913

121GR18M081-FD04

MB06100251804

US 25E (MP 3.385). BRIDGE OVER STINKING CREEK. BRIDGE REPAIRS EXPANSION JOINTS.

Project Line No	Bid Code	DESCRIPTION	Quantity	Unit
0220	02650	MAINTAIN & CONTROL TRAFFIC - APPLIES TO 061B00091L	1.00	LS
0225	24981EC	BRIDGE CLEANING - APPLIES TO 061B00091L	1.00	LS
0230	02569	DEMOBILIZATION	1.00	LS
0235	24439EC	SEAL BRIDGE DECK	1.00	LS
0240	02650	MAINTAIN & CONTROL TRAFFIC - APPLIES TO 061B00091R	1.00	LS
0245	24439EC	SEAL BRIDGE DECK	1.00	LS
0250	24981EC	BRIDGE CLEANING - APPLIES TO 061B00092R	1.00	LS

CONTRACT ID: 182913

121GR18M081-FD04

MB06100251805

US 25E (MP 1.495). BRIDGE OVER CSX RR. BRIDGE REPAIRS EXPANSION JOINTS.

Project Line No	Bid Code	DESCRIPTION	Quantity	Unit
0255	02650	MAINTAIN & CONTROL TRAFFIC - APPLIES TO 061B00090L	1.00	LS
0260	24981EC	BRIDGE CLEANING - APPLIES TO 061B00090L	1.00	LS
0265	02569	DEMOBILIZATION	1.00	LS
0270	24439EC	SEAL BRIDGE DECK	1.00	LS
0275	02650	MAINTAIN & CONTROL TRAFFIC - APPLIES TO 061B00090R	1.00	LS
0280	24439EC	SEAL BRIDGE DECK	1.00	LS
0285	24981EC	BRIDGE CLEANING - APPLIES TO 061B00090R	1.00	LS

MATERIAL SUMMARY

CONTRACT ID: 182913

121GR18M081-FD04

MB06100251806

US 25E (MP 0.821). BRIDGE OVER CUMBERLAND RIVER. BRIDGE REPAIRS EXPANSION JOINTS.

Project Line No	Bid Code	DESCRIPTION	Quantity	Unit
0290	02650	MAINTAIN & CONTROL TRAFFIC - APPLIES TO 061B00089L	1.00	LS
0295	03298	EXPAN JOINT REPLACE 4 IN	82.80	LF
0300	03299	ARMORED EDGE FOR CONCRETE	82.80	LF
0305	24981EC	BRIDGE CLEANING - APPLIES TO 061B00089L	1.00	LS
0310	24982EC	CONCRETE COATING - APPLIES TO 061B00089L	1.00	LS
0315	02569	DEMOBILIZATION	1.00	LS
0320	24439EC	SEAL BRIDGE DECK	1.00	LS
0325	02650	MAINTAIN & CONTROL TRAFFIC - APPLIES TO 061B00089R	1.00	LS
0330	03298	EXPAN JOINT REPLACE 4 IN	82.80	LF
0335	03299	ARMORED EDGE FOR CONCRETE	82.80	LF
0340	24439EC	SEAL BRIDGE DECK	1.00	LS
0345	24981EC	BRIDGE CLEANING - APPLIES TO 061B00089R	1.00	LS
0350	24982EC	CONCRETE COATING - APPLIES TO 061B00089R	1.00	LS

CONTRACT ID: 182913

121GR18M081-FD04

MB06300251801

US 25E (MP 1.366). BRIDGE OVER CSX RR. BRIDGE REPAIRS EXPANSION JOINTS.

Project Line No	Bid Code	DESCRIPTION	Quantity	Unit
0005	02650	MAINTAIN & CONTROL TRAFFIC - APPLIES TO 063B00058L	1.00	LS
0010	02569	DEMOBILIZATION	1.00	LS
0015	24981EC	BRIDGE CLEANING - APPLIES TO 063B00058L	1.00	LS
0020	24982EC	CONCRETE COATING - APPLIES TO 063B00058L	1.00	LS
0025	24983EC	BEARING LUBRICATION	20.00	EACH
0030	24439EC	SEAL BRIDGE DECK	1.00	LS
0035	02650	MAINTAIN & CONTROL TRAFFIC - APPLIES TO 063B00058R	1.00	LS
0040	24439EC	SEAL BRIDGE DECK	1.00	LS
0045	24981EC	BRIDGE CLEANING - APPLIES TO 063B00058R	1.00	LS
0050	24982EC	CONCRETE COATING - APPLIES TO 063B00058R	1.00	LS
0055	24983EC	BEARING LUBRICATION	20.00	EACH

PART II
SPECIFICATIONS AND STANDARD DRAWINGS

SPECIFICATIONS REFERENCE

Any reference in the plans or proposal to previous editions of the *Standard Specifications for Road and Bridge Construction* and *Standard Drawings* are superseded by *Standard Specifications for Road and Bridge Construction, Edition of 2012* and *Standard Drawings, Edition of 2016*.

SUPPLEMENTAL SPECIFICATIONS

The contractor shall use the Supplemental Specifications that are effective at the time of letting.
The Supplemental Specifications can be found at the following link:

<http://transportation.ky.gov/Construction/Pages/Kentucky-Standard-Specifications.aspx>

PART III

EMPLOYMENT, WAGE AND RECORD REQUIREMENTS

**TRANSPORTATION CABINET
DEPARTMENT OF HIGHWAYS**

**LABOR AND WAGE REQUIREMENTS
APPLICABLE TO OTHER THAN FEDERAL-AID SYSTEM PROJECTS**

- I. Application
- II. Nondiscrimination of Employees (KRS 344)

I. APPLICATION

1. These contract provisions shall apply to all work performed on the contract by the contractor with his own organization and with the assistance of workmen under his immediate superintendence and to all work performed on the contract by piecework, station work or by subcontract. The contractor's organization shall be construed to include only workmen employed and paid directly by the contractor and equipment owned or rented by him, with or without operators.

2. The contractor shall insert in each of his subcontracts all of the stipulations contained in these Required Provisions and such other stipulations as may be required.

3. A breach of any of the stipulations contained in these Required Provisions may be grounds for termination of the contract.

3. If the contractor is in control of apprenticeship or other training or retraining, including on-the-job training programs, he shall not discriminate against an individual because of his race, color, religion, national origin, sex, disability or age forty (40) and over, in admission to, or employment in any program established to provide apprenticeship or other training.

4. The contractor will send to each labor union or representative of workers with which he has a collective bargaining agreement or other contract or understanding, a notice to be provided advising the said labor union or workers' representative of the contractor's commitments under this section, and shall post copies of the notice in conspicuous places available to employees and applicants for employment. The contractor will take such action with respect to any subcontract or purchase order as the administrating agency may direct as a means of enforcing such provisions, including sanctions for non-compliance.

Revised: January 25, 2017

II. NONDISCRIMINATION OF EMPLOYEES

**AN ACT OF THE KENTUCKY
GENERAL ASSEMBLY TO PREVENT
DISCRIMINATION IN EMPLOYMENT
KRS CHAPTER 344
EFFECTIVE JUNE 16, 1972**

The contract on this project, in accordance with KRS Chapter 344, provides that during the performance of this contract, the contractor agrees as follows:

1. The contractor shall not fail or refuse to hire, or shall not discharge any individual, or otherwise discriminate against an individual with respect to his compensation, terms, conditions, or privileges of employment, because of such individual's race, color, religion, national origin, sex, disability or age (forty and above); or limit, segregate, or classify his employees in any way which would deprive or tend to deprive an individual of employment opportunities or otherwise adversely affect his status as an employee, because of such individual's race, color, religion, national origin, sex, disability or age forty (40) and over. The contractor agrees to post in conspicuous places, available to employees and applicants for employment, notices to be provided setting forth the provisions of this nondiscrimination clause.

2. The contractor shall not print or publish or cause to be printed or published a notice or advertisement relating to employment by such an employer or membership in or any classification or referral for employment by the employment agency, indicating any preference, limitation, specification, or discrimination, based on race, color, religion, national origin, sex, or age forty (40) and over, or because the person is a qualified individual with a disability, except that such a notice or advertisement may indicate a preference, limitation, or specification based on religion, national origin, sex, or age forty (40) and over, or because the person is a qualified individual with a disability, when religion, national origin, sex, or age forty (40) and over, or because the person is a qualified individual with a disability, is a bona fide occupational qualification for employment.

EXECUTIVE BRANCH CODE OF ETHICS

In the 1992 regular legislative session, the General Assembly passed and Governor Brereton Jones signed Senate Bill 63 (codified as KRS 11A), the Executive Branch Code of Ethics, which states, in part:

KRS 11A.040 (7) provides:

No present or former public servant shall, within six (6) months following termination of his office or employment, accept employment, compensation, or other economic benefit from any person or business that contracts or does business with, or is regulated by, the state in matters in which he was directly involved during the last thirty-six (36) months of his tenure. This provision shall not prohibit an individual from returning to the same business, firm, occupation, or profession in which he was involved prior to taking office or beginning his term of employment, or for which he received, prior to his state employment, a professional degree or license, provided that, for a period of six (6) months, he personally refrains from working on any matter in which he was directly involved during the last thirty-six (36) months of his tenure in state government. This subsection shall not prohibit the performance of ministerial functions, including but not limited to filing tax returns, filing applications for permits or licenses, or filing incorporation papers, nor shall it prohibit the former officer or public servant from receiving public funds disbursed through entitlement programs.

KRS 11A.040 (9) states:

A former public servant shall not represent a person or business before a state agency in a matter in which the former public servant was directly involved during the last thirty-six (36) months of his tenure, for a period of one (1) year after the latter of:

- a) The date of leaving office or termination of employment; or
- b) The date the term of office expires to which the public servant was elected.

This law is intended to promote public confidence in the integrity of state government and to declare as public policy the idea that state employees should view their work as a public trust and not as a way to obtain private benefits.

If you have worked for the executive branch of state government within the past six months, you may be subject to the law's prohibitions. The law's applicability may be different if you hold elected office or are contemplating representation of another before a state agency.

Also, if you are affiliated with a firm which does business with the state and which employs former state executive-branch employees, you should be aware that the law may apply to them.

In case of doubt, the law permits you to request an advisory opinion from the Executive Branch Ethics Commission, 3 Fountain Place, Frankfort, Kentucky 40601; telephone (502) 564-7954.

Revised: January 27, 2017

Kentucky Equal Employment Opportunity Act of 1978

The requirements of the Kentucky Equal Employment Opportunity Act of 1978 (KRS 45.560-45.640) shall apply to this Contract. The apparent low Bidder will be required to submit EEO forms to the Division of Construction Procurement, which will then forward to the Finance and Administration Cabinet for review and approval. No award will become effective until all forms are submitted and EEO/CC has certified compliance. The required EEO forms are as follows:

- EEO-1: Employer Information Report
- Affidavit of Intent to Comply
- Employee Data Sheet
- Subcontractor Report

These forms are available on the Finance and Administration's web page under ***Vendor Information, Standard Attachments and General Terms*** at the following address:
<https://www.eProcurement.ky.gov>.

Bidders currently certified as being in compliance by the Finance and Administration Cabinet may submit a copy of their approval letter in lieu of the referenced EEO forms.

For questions or assistance please contact the Finance and Administration Cabinet by email at **finance.contractcompliance@ky.gov** or by phone at 502-564-2874.

EMPLOYEE RIGHTS UNDER THE FAIR LABOR STANDARDS ACT

THE UNITED STATES DEPARTMENT OF LABOR WAGE AND HOUR DIVISION

FEDERAL MINIMUM WAGE

\$7.25

 PER HOUR

BEGINNING JULY 24, 2009

OVERTIME PAY At least 1½ times your regular rate of pay for all hours worked over 40 in a workweek.

CHILD LABOR An employee must be at least **16** years old to work in most non-farm jobs and at least **18** to work in non-farm jobs declared hazardous by the Secretary of Labor.

Youths **14** and **15** years old may work outside school hours in various non-manufacturing, non-mining, non-hazardous jobs under the following conditions:

No more than

- **3** hours on a school day or **18** hours in a school week;
- **8** hours on a non-school day or **40** hours in a non-school week.

Also, work may not begin before **7 a.m.** or end after **7 p.m.**, except from June 1 through Labor Day, when evening hours are extended to **9 p.m.** Different rules apply in agricultural employment.

TIP CREDIT Employers of “tipped employees” must pay a cash wage of at least \$2.13 per hour if they claim a tip credit against their minimum wage obligation. If an employee’s tips combined with the employer’s cash wage of at least \$2.13 per hour do not equal the minimum hourly wage, the employer must make up the difference. Certain other conditions must also be met.

ENFORCEMENT The Department of Labor may recover back wages either administratively or through court action, for the employees that have been underpaid in violation of the law. Violations may result in civil or criminal action.

Employers may be assessed civil money penalties of up to \$1,100 for each willful or repeated violation of the minimum wage or overtime pay provisions of the law and up to \$11,000 for each employee who is the subject of a violation of the Act’s child labor provisions. In addition, a civil money penalty of up to \$50,000 may be assessed for each child labor violation that causes the death or serious injury of any minor employee, and such assessments may be doubled, up to \$100,000, when the violations are determined to be willful or repeated. The law also prohibits discriminating against or discharging workers who file a complaint or participate in any proceeding under the Act.

ADDITIONAL INFORMATION

- Certain occupations and establishments are exempt from the minimum wage and/or overtime pay provisions.
- Special provisions apply to workers in American Samoa and the Commonwealth of the Northern Mariana Islands.
- Some state laws provide greater employee protections; employers must comply with both.
- The law requires employers to display this poster where employees can readily see it.
- Employees under 20 years of age may be paid \$4.25 per hour during their first 90 consecutive calendar days of employment with an employer.
- Certain full-time students, student learners, apprentices, and workers with disabilities may be paid less than the minimum wage under special certificates issued by the Department of Labor.

For additional information:



1-866-4-USWAGE

(1-866-487-9243)

TTY: 1-877-889-5627



WWW.WAGEHOUR.DOL.GOV

PART IV
INSURANCE

INSURANCE

The Contractor shall procure and maintain the following insurance in addition to the insurance required by law:

- 1) Commercial General Liability-Occurrence form – not less than \$2,000,000 General aggregate, \$2,000,000 Products & Completed Aggregate, \$1,000,000 Personal & Advertising, \$1,000,000 each occurrence.
- 2) Automobile Liability- \$1,000,000 per accident
- 3) Employers Liability:
 - a) \$100,000 Each Accident Bodily Injury
 - b) \$500,000 Policy limit Bodily Injury by Disease
 - c) \$100,000 Each Employee Bodily Injury by Disease
- 4) The insurance required above must be evidenced by a Certificate of Insurance and this Certificate of Insurance must contain one of the following statements:
 - a) "policy contains no deductible clauses."
 - b) "policy contains _____ (amount) deductible property damage clause but company will pay claim and collect the deductible from the insured."
- 5) KENTUCKY WORKMEN'S COMPENSATION INSURANCE. The contractor shall furnish evidence of coverage of all his employees or give evidence of self-insurance by submitting a copy of a certificate issued by the Workmen's Compensation Board.

The cost of insurance is incidental to all contract items. All subcontractors must meet the same minimum insurance requirements.

PART V
BID ITEMS

PROPOSAL BID ITEMS

182913

Page 1 of 6

Report Date 10/15/18

Section: 0001 - BRIDGE

LINE	BID CODE	ALT	DESCRIPTION	QUANTITY	UNIT	UNIT PRIC	FP	AMOUNT
0010	02650		MAINTAIN & CONTROL TRAFFIC APPLIES TO 007B00131L	1.00	LS		\$	
0020	03296		EXPAN JOINT REPLACE 2 1/2 IN	85.10	LF		\$	
0030	03298		EXPAN JOINT REPLACE 4 IN	127.70	LF		\$	
0040	08150		STEEL REINFORCEMENT	1,336.00	LB		\$	
0050	24439EC		SEAL BRIDGE DECK	1.00	LS		\$	
0060	24981EC		BRIDGE CLEANING APPLIES TO 007B00131L	1.00	LS		\$	
0070	24982EC		CONCRETE COATING APPLIES TO 007B00131L	1.00	LS		\$	

Section: 0002 - BRIDGE

LINE	BID CODE	ALT	DESCRIPTION	QUANTITY	UNIT	UNIT PRIC	FP	AMOUNT
0080	02650		MAINTAIN & CONTROL TRAFFIC APPLIES TO 007B00130L.	1.00	LS		\$	
0090	23386EC		JOINT SEAL REPLACEMENT	145.00	LF		\$	
0100	24439EC		SEAL BRIDGE DECK	1.00	LS		\$	
0110	24981EC		BRIDGE CLEANING APPLIES TO 007B00130L.	1.00	LS		\$	
0115	24982EC		CONCRETE COATING APPLIES TO 007B00130L (ADDED: 10-15-18)	1.00	LS		\$	

Section: 0003 - BRIDGE

LINE	BID CODE	ALT	DESCRIPTION	QUANTITY	UNIT	UNIT PRIC	FP	AMOUNT
0120	02650		MAINTAIN & CONTROL TRAFFIC APPLIES TO 007B00026N	1.00	LS		\$	
0130	24439EC		SEAL BRIDGE DECK	1.00	LS		\$	
0140	24981EC		BRIDGE CLEANING APPLIES TO 007B00026N	1.00	LS		\$	
0150	24982EC		CONCRETE COATING APPLIES TO 007B00026N	1.00	LS		\$	
0160	24983EC		BEARING LUBRICATION	20.00	EACH		\$	

Section: 0004 - BRIDGE

LINE	BID CODE	ALT	DESCRIPTION	QUANTITY	UNIT	UNIT PRIC	FP	AMOUNT
0170	02650		MAINTAIN & CONTROL TRAFFIC APPLIES TO 007B00126N	1.00	LS		\$	
0180	23386EC		JOINT SEAL REPLACEMENT	152.00	LF		\$	
0190	24439EC		SEAL BRIDGE DECK	1.00	LS		\$	
0200	24981EC		BRIDGE CLEANING APPLIES TO 007B00126N	1.00	LS		\$	

PROPOSAL BID ITEMS

182913

Report Date 10/15/18

Section: 0005 - BRIDGE

LINE	BID CODE	ALT	DESCRIPTION	QUANTITY	UNIT	UNIT PRIC	FP	AMOUNT
0210	02650		MAINTAIN & CONTROL TRAFFIC APPLIES TO 007B00137N	1.00	LS		\$	
0220	24439EC		SEAL BRIDGE DECK	1.00	LS		\$	

Section: 0006 - BRIDGE

LINE	BID CODE	ALT	DESCRIPTION	QUANTITY	UNIT	UNIT PRIC	FP	AMOUNT
0230	02650		MAINTAIN & CONTROL TRAFFIC APPLIES TO 007B00136L	1.00	LS		\$	
0240	24439EC		SEAL BRIDGE DECK	1.00	LS		\$	

Section: 0007 - BRIDGE

LINE	BID CODE	ALT	DESCRIPTION	QUANTITY	UNIT	UNIT PRIC	FP	AMOUNT
0250	02650		MAINTAIN & CONTROL TRAFFIC APPLIES TO 061B00081L	1.00	LS		\$	
0260	03300		ELIMINATE TRANSVERSE JOINT	40.00	LF		\$	
0270	24439EC		SEAL BRIDGE DECK	1.00	LS		\$	
0280	24981EC		BRIDGE CLEANING APPLIES TO 061B00081L	1.00	LS		\$	
0290	24983EC		BEARING LUBRICATION	10.00	EACH		\$	

Section: 0008 - BRIDGE

LINE	BID CODE	ALT	DESCRIPTION	QUANTITY	UNIT	UNIT PRIC	FP	AMOUNT
0300	02650		MAINTAIN & CONTROL TRAFFIC APPLIES TO 061B00082L	1.00	LS		\$	
0310	23386EC		JOINT SEAL REPLACEMENT	93.00	LF		\$	
0320	24439EC		SEAL BRIDGE DECK	1.00	LS		\$	
0330	24981EC		BRIDGE CLEANING APPLIES TO 061B00082L	1.00	LS		\$	
0340	24982EC		CONCRETE COATING APPLIES TO 061B00082L	1.00	LS		\$	
0350	24983EC		BEARING LUBRICATION	8.00	EACH		\$	

Section: 0009 - BRIDGE

LINE	BID CODE	ALT	DESCRIPTION	QUANTITY	UNIT	UNIT PRIC	FP	AMOUNT
0360	02650		MAINTAIN & CONTROL TRAFFIC APPLIES TO 061B00092L	1.00	LS		\$	
0370	24439EC		SEAL BRIDGE DECK	1.00	LS		\$	
0380	24981EC		BRIDGE CLEANING APPLIES TO 061B00092L	1.00	LS		\$	

PROPOSAL BID ITEMS

REVISED ADDENDUM #1: 10-15-18

182913

Page 3 of 6

Report Date 10/15/18

Section: 0010 - BRIDGE

LINE	BID CODE	ALT	DESCRIPTION	QUANTITY	UNIT	UNIT PRIC	FP	AMOUNT
0390	02650		MAINTAIN & CONTROL TRAFFIC APPLIES TO 061B00091L	1.00	LS		\$	
0400	24439EC		SEAL BRIDGE DECK	1.00	LS		\$	
0410	24981EC		BRIDGE CLEANING APPLIES TO 061B00091L	1.00	LS		\$	

Section: 0011 - BRIDGE

LINE	BID CODE	ALT	DESCRIPTION	QUANTITY	UNIT	UNIT PRIC	FP	AMOUNT
0420	02650		MAINTAIN & CONTROL TRAFFIC APPLIES TO 061B00090L	1.00	LS		\$	
0430	24439EC		SEAL BRIDGE DECK	1.00	LS		\$	
0440	24981EC		BRIDGE CLEANING APPLIES TO 061B00090L	1.00	LS		\$	

Section: 0012 - BRIDGE

LINE	BID CODE	ALT	DESCRIPTION	QUANTITY	UNIT	UNIT PRIC	FP	AMOUNT
0450	02650		MAINTAIN & CONTROL TRAFFIC APPLIES TO 061B00089L	1.00	LS		\$	
0460	03298		EXPAN JOINT REPLACE 4 IN	82.80	LF		\$	
0470	03299		ARMORED EDGE FOR CONCRETE	82.80	LF		\$	
0480	24439EC		SEAL BRIDGE DECK	1.00	LS		\$	
0490	24981EC		BRIDGE CLEANING APPLIES TO 061B00089L	1.00	LS		\$	
0500	24982EC		CONCRETE COATING APPLIES TO 061B00089L	1.00	LS		\$	

Section: 0013 - BRIDGE

LINE	BID CODE	ALT	DESCRIPTION	QUANTITY	UNIT	UNIT PRIC	FP	AMOUNT
0510	02650		MAINTAIN & CONTROL TRAFFIC APPLIES TO 063B00058L	1.00	LS		\$	
0520	24439EC		SEAL BRIDGE DECK	1.00	LS		\$	
0530	24981EC		BRIDGE CLEANING APPLIES TO 063B00058L	1.00	LS		\$	
0540	24982EC		CONCRETE COATING APPLIES TO 063B00058L	1.00	LS		\$	
0550	24983EC		BEARING LUBRICATION	20.00	EACH		\$	

Section: 0014 - BRIDGE

LINE	BID CODE	ALT	DESCRIPTION	QUANTITY	UNIT	UNIT PRIC	FP	AMOUNT
0560	02650		MAINTAIN & CONTROL TRAFFIC APPLIES TO 007B00131R	1.00	LS		\$	
0570	03296		EXPAN JOINT REPLACE 2 1/2 IN	85.10	LF		\$	

PROPOSAL BID ITEMS

182913

Page 4 of 6

Report Date 10/15/18

LINE	BID CODE	ALT	DESCRIPTION	QUANTITY	UNIT	UNIT PRIC	FP	AMOUNT
0580	03298		EXPAN JOINT REPLACE 4 IN	127.70	LF		\$	
0590	24439EC		SEAL BRIDGE DECK	1.00	LS		\$	
0600	24981EC		BRIDGE CLEANING APPLIES TO 007B00131R	1.00	LS		\$	
0610	24982EC		CONCRETE COATING APPLIES TO 007B00131R	1.00	LS		\$	

Section: 0015 - BRIDGE

LINE	BID CODE	ALT	DESCRIPTION	QUANTITY	UNIT	UNIT PRIC	FP	AMOUNT
0620	02650		MAINTAIN & CONTROL TRAFFIC APPLIES TO 007B00130R.	1.00	LS		\$	
0630	23386EC		JOINT SEAL REPLACEMENT	145.00	LF		\$	
0640	24439EC		SEAL BRIDGE DECK	1.00	LS		\$	
0650	24981EC		BRIDGE CLEANING APPLIES TO 007B00130R.	1.00	LS		\$	
0655	24982EC		CONCRETE COATING APPLIES TO 007B00130R (ADDED: 10-15-18)	1.00	LS		\$	

Section: 0016 - BRIDGE

LINE	BID CODE	ALT	DESCRIPTION	QUANTITY	UNIT	UNIT PRIC	FP	AMOUNT
0660	02650		MAINTAIN & CONTROL TRAFFIC APPLIES TO 007B00136R	1.00	LS		\$	
0670	24439EC		SEAL BRIDGE DECK	1.00	LS		\$	

Section: 0017 - BRIDGE

LINE	BID CODE	ALT	DESCRIPTION	QUANTITY	UNIT	UNIT PRIC	FP	AMOUNT
0680	02650		MAINTAIN & CONTROL TRAFFIC APPLIES TO 061B00081R	1.00	LS		\$	
0690	03296		EXPAN JOINT REPLACE 2 1/2 IN	80.00	LF		\$	
0700	03299		ARMORED EDGE FOR CONCRETE	80.00	LF		\$	
0710	24439EC		SEAL BRIDGE DECK	1.00	LS		\$	
0720	24981EC		BRIDGE CLEANING APPLIES TO 061B00081R	1.00	LS		\$	
0730	24982EC		CONCRETE COATING APPLIES TO 061B00081R	1.00	LS		\$	
0740	24983EC		BEARING LUBRICATION	10.00	EACH		\$	

Section: 0018 - BRIDGE

LINE	BID CODE	ALT	DESCRIPTION	QUANTITY	UNIT	UNIT PRIC	FP	AMOUNT
0750	02650		MAINTAIN & CONTROL TRAFFIC APPLIES TO 061B00082R	1.00	LS		\$	
0760	23386EC		JOINT SEAL REPLACEMENT	93.00	LF		\$	
0770	24439EC		SEAL BRIDGE DECK	1.00	LS		\$	

PROPOSAL BID ITEMS

182913

Page 5 of 6

Report Date 10/15/18

LINE	BID CODE	ALT	DESCRIPTION	QUANTITY	UNIT	UNIT PRIC	FP	AMOUNT
0780	24981EC		BRIDGE CLEANING APPLIES TO 061B00082R	1.00	LS		\$	
0790	24982EC		CONCRETE COATING APPLIES TO 061B00082R	1.00	LS		\$	

Section: 0019 - BRIDGE

LINE	BID CODE	ALT	DESCRIPTION	QUANTITY	UNIT	UNIT PRIC	FP	AMOUNT
0800	02650		MAINTAIN & CONTROL TRAFFIC APPLIES TO 061B00092R	1.00	LS		\$	
0810	24439EC		SEAL BRIDGE DECK	1.00	LS		\$	
0820	24981EC		BRIDGE CLEANING APPLIES TO 061B00092R	1.00	LS		\$	

Section: 0020 - BRIDGE

LINE	BID CODE	ALT	DESCRIPTION	QUANTITY	UNIT	UNIT PRIC	FP	AMOUNT
0830	02650		MAINTAIN & CONTROL TRAFFIC APPLIES TO 061B00091R	1.00	LS		\$	
0840	24439EC		SEAL BRIDGE DECK	1.00	LS		\$	
0850	24981EC		BRIDGE CLEANING APPLIES TO 061B00092R	1.00	LS		\$	

Section: 0021 - BRIDGE

LINE	BID CODE	ALT	DESCRIPTION	QUANTITY	UNIT	UNIT PRIC	FP	AMOUNT
0860	02650		MAINTAIN & CONTROL TRAFFIC APPLIES TO 061B00090R	1.00	LS		\$	
0870	24439EC		SEAL BRIDGE DECK	1.00	LS		\$	
0880	24981EC		BRIDGE CLEANING APPLIES TO 061B00090R	1.00	LS		\$	

Section: 0022 - BRIDGE

LINE	BID CODE	ALT	DESCRIPTION	QUANTITY	UNIT	UNIT PRIC	FP	AMOUNT
0890	02650		MAINTAIN & CONTROL TRAFFIC APPLIES TO 061B00089R	1.00	LS		\$	
0900	03298		EXPAN JOINT REPLACE 4 IN	82.80	LF		\$	
0910	03299		ARMORED EDGE FOR CONCRETE	82.80	LF		\$	
0920	24439EC		SEAL BRIDGE DECK	1.00	LS		\$	
0930	24981EC		BRIDGE CLEANING APPLIES TO 061B00089R	1.00	LS		\$	
0940	24982EC		CONCRETE COATING APPLIES TO 061B00089R	1.00	LS		\$	

Section: 0023 - BRIDGE

PROPOSAL BID ITEMS

182913

Page 6 of 6

Report Date 10/15/18

LINE	BID CODE	ALT	DESCRIPTION	QUANTITY	UNIT	UNIT PRIC	FP	AMOUNT
0950	02650		MAINTAIN & CONTROL TRAFFIC APPLIES TO 063B00058R	1.00	LS		\$	
0960	24439EC		SEAL BRIDGE DECK	1.00	LS		\$	
0970	24981EC		BRIDGE CLEANING APPLIES TO 063B00058R	1.00	LS		\$	
0980	24982EC		CONCRETE COATING APPLIES TO 063B00058R	1.00	LS		\$	
0990	24983EC		BEARING LUBRICATION	20.00	EACH		\$	

Section: 0024 - DEMOBILIZATION

LINE	BID CODE	ALT	DESCRIPTION	QUANTITY	UNIT	UNIT PRIC	FP	AMOUNT
1000	02569		DEMOBILIZATION	1.00	LS		\$	